

BENCHTOP & MICROCENTRIFUGES

SIMPLICITY AND VERSATILITY

PRODUCT CATALOG







COMPACT YET POWERFUL
VERSATILE BY DESIGN
ULTRA-HARMONIC TECHNOLOGY
WORKFLOW SUPPORTING
LABORATORY WORKHORSE
SIMPLIFIED OPERATION

Since the introduction of the first commercial ultracentrifuge in 1947 – the classic Beckman Model L – Beckman Coulter has been at the forefront of centrifuge innovation. Although the physics of this basic separation technique never change, Beckman Coulter continually designs new and innovative rotors and accessories, and develops advanced methods that allow the forces of centrifugation to be applied in new ways.

This centrifuge product selection guide is designed to help you determine the most efficient centrifuge tools for your laboratory.

Each section begins with a brief description of instruments that Beckman Coulter offers within that centrifuge category. Because biocontainment is a major concern in today's laboratories, Beckman Coulter provides a number of options that address this issue. Special BioSafe instruments and accessories are available across our centrifuge product line and are identified with this icon:

 **BioSafe and BioSafety** are terms intended to describe the enhanced biocontainment features of our products.

 **BioCertified** is a term used to describe our products which have been tested and validated to demonstrate containment of microbiological aerosols by an independent, third-party facility (Health Protection Agency, Porton Down, UK). Improper use or maintenance may affect seal integrity and, thus, containment.

Rotors with the BioCertified symbol have been tested to demonstrate containment of aerosols under normal operating conditions of the associated Beckman Coulter centrifuge when used and maintained as instructed.

Following the centrifuge descriptions, listings of their rotors are included with information on speed and g-force capability. Also included is information on tubes and bottles that can be used and the adapters they require.



Tubes and bottles are cross-referenced in a separate section which provides details on tube materials, chemical compatibility, tube designs, and tube closure options.

A reference section at the back of the guide includes quick reference charts on instrument and tube selection as well as frequently used formulas.



Contact your local Beckman Coulter office
Please visit us at beckman.com/contact-us

Additional centrifugation resources:
beckman.com/centrifuges

1. Benchtop Centrifugation

Instruments

Avanti J-15R Benchtop Centrifuge1-1
 Avanti J-15 Benchtop Centrifuge.....1-2
 Allegra X-30 Series Compact Multipurpose Benchtop Centrifuges1-3
 Allegra 64R Centrifuge.....1-4
 Allegra X-5 Clinical Benchtop Centrifuge.....1-5
 Centrifuge and Rotor Sales Groups1-6
 Benchtop Centrifuges Rotor Summary.....1-7

Fixed-Angle Rotors

F12021-8
 F0630.....1-9
 F2402H.....1-10
 F1010.....1-11
 F3602.....1-12
 F0650.....1-13
 F0485.....1-14
 F0850.....1-15
 F0685.....1-16
 FX301.5.....1-17
 JA-10.1001-18
 C1015.....1-19
 C0650.....1-20

Swinging-Bucket Rotors

SX241.51-21
 H6002.....1-22
 S0410.....1-23
 SX42501-24
 SX44001-25
 JS-4.750.....1-26
 S2096.....1-30
 S6096.....1-31
 SX47001-32

2. Microcentrifugation

Instruments

Microfuge 16 Microcentrifuge.....2-1
 Microfuge 20 Series Microcentrifuge2-2
 Centrifuge and Rotor Sales Groups2-3
 Microfuge Centrifuges Rotor Summary.....2-3

Fixed-Angle Rotors

FA241.52-4
 FA241.5P2-5
 FA361.5.....2-6
 FA4x8.2P2-7
 FX121.5P2-8
 FX241.5P2-9



3. Tubes & Bottles

Tubes and Bottles for Every Application3-1

Tube Selection Considerations

Compatibility of Tube Material with Solvents and Sample.....3-2

Gradient Formation and Fractionation.....3-2

High Temperature Centrifugation3-2

Tube Sizes3-2

Tube Cleaning, Sterilization, and Reuse 3-3

Tube Closures..... 3-3

A Quick-Reference Chart to Tube Materials and Their Properties3-4

General Filling and Sealing Requirements for Tubes and Bottles.....3-4

Bottles Used in Benchtop Centrifuges3-5

Adapters for Non-Beckman Coulter Tubes/Bottles.....3-6

Adapters for Glass Tubes in Beckman Coulter Rotors....3-6

Tubes and Bottles Used in Benchtop Centrifuges and Microcentrifuges3-7

4. Tools and Supplies

Rotor Cleaning Kit 4-1

5. Reference

Useful Formulas5-1

6. Support

Field Service Support 6-1

Field Rotor Inspection Program..... 6-1

Rotor Safety Seminars 6-1

On-Site Rotor Inspection and Maintenance..... 6-1

A Comprehensive Approach to Centrifuge System Care 6-1



Avanti J-15R Benchtop Centrifuge



The Avanti J-15 Series of benchtop centrifuges is part of a new family of life science equipment that provides the exceptional performance you expect from Beckman Coulter. The refrigerated Avanti J-15R centrifuges leverage Ultra Harmonic Technology, from the industry trusted Optima X series ultracentrifuge products providing time savings when conducting experiments. The Avanti J-15 series is an all around solution for your scientific needs.

Achieve Up to 5,250 x g in your 4 x 750 mL Swinging-Bucket Rotor

- Optimize recoveries
- Faster separations
- Save time
- Perfect for:
 - Filtration and concentration
 - Fast and slow blood component spins
 - Microbial cell harvesting

Directly centrifuge your cell culture flasks

- Save time and labor
- Eliminate 15 mL or 50 mL conical tubes
- Reduce a potential contamination step



JS-4.750 rotor shown with optional accessories

Enhanced workflow features

- Ultra Harmonic Technology minimizes sample disruption during acceleration and deceleration
- Fast and accurate imbalance detection within 30 sec of start
- Easy to use icon-based touchscreen for use in all regions
- Low lift over height which enables easier rotor swapping

	Configuration	Part Number
IVD	200-230V, 50Hz	B99515
	208-230V, 60Hz	C31547
	120V, 60Hz	B99517
Non-IVD	200-230V, 50Hz	B99514
	208-230V, 60Hz	C31546
	120V, 60Hz	B99516

Centrifuge and Rotor Sales Groups available on page 1-6.

Specifications	
Maximum Speed	10,200 rpm
Maximum g-force	11,420 x g
Set Speed	± 10 rpm of set speed
Drive Type	Brushless induction
Time Setting	Set (up to 99 hours 59 minutes), Hold or Pulse (short run)
User-Defined Programs	99
Accel/Decel Rates	10 accel, 11 decel
Set Temperature	-10° to +40°C
Dimensions	36.8 cm (14.5 in) H x 70.3 cm (27.7 in) D x 75.6 cm (29.8 in) W
Weight	120 kg (265 lb)

Avanti J-15 Benchtop Centrifuge



The truly ventilated Avanti J-15 centrifuge utilizes laboratory air to effectively maintain sample temperature while spinning cell cultures, blood separations or microbiology type protocols.

Directly centrifuge your cell culture flasks

- Save time and labor
- Eliminate 15 mL or 50 mL conical tubes
- Reduce a potential contamination step

Enhanced workflow features

- Optimized bench space with truly ventilated model
- Ultra Harmonic Technology minimizes sample disruption during acceleration and deceleration
- Fast and accurate imbalance detection within 30 sec of start
- Easy to use icon-based touchscreen for use in all regions
- Low lift over height which enables easier rotor swapping



JS-4.750 rotor shown with microplate carriers and optional BioSafe covers

	Configuration	Part Number
IVD	All Voltages	C01994
Non-IVD	All Voltages	C01995

Centrifuge and Rotor Sales Groups available on page 1-6.

Specifications	
Maximum Speed	10,200 rpm
Maximum <i>g</i> -force	11,420 <i>g</i>
Set Speed	± 10 rpm of set speed
Drive Type	Brushless induction
Time Setting	Set (up to 99 hours 59 minutes), Hold, or Pulse (short run)
User-Defined Programs	99
Accel/Decel Rates	10 accel, 11 decel
Dimensions	36.8 cm (14.5 in) H x 74.9 cm (29.5 in) D x 55.6 cm (21.9 in) W
Weight	93 kg (205 lb)

Allegra X-30 Series Compact Multipurpose Benchtop Centrifuges



The compact Allegra X-30 Series is up to 25 cm (10 inches) thinner than other comparable benchtop centrifuges. With a library of eleven rotors, the Allegra X-30 Series is the space-saving multipurpose solution for your requirements.



Allegra X-30 Centrifuge

Allegra X-30R	Configuration	Part Number
IVD	220-240V, 50/60Hz	B06322
	220-240V, 50/60Hz, CCC Plug	B06321
	120V, 60Hz	B06320
Non-IVD	100V, 50/60Hz	B06323
	220-240V, 50/60Hz	A99471
	220-240V, 50/60Hz, CCC Plug	A99472
	120V, 60Hz	A99470
	100V, 50/60Hz	A99473

Centrifuge and Rotor Sales Groups available on page 1-6.

Allegra X-30	Configuration	Part Number
IVD	220-240V, 50/60Hz	B06315
	220-240V, 50/60Hz, CCC Plug	B06318
	120V, 60Hz	B06314
	100V, 50/60Hz	B06319
Non-IVD	220-240V, 50/60Hz	A99467
	220-240V, 50/60Hz, CCC Plug	A99468
	120V, 60Hz	A99466
	100V, 50/60Hz	A99469

Centrifuge and Rotor Sales Groups available on page 1-6.

Specifications	Allegra X-30R	Allegra X-30
Maximum Speed	18,000 rpm	16,000 rpm
Maximum <i>g</i> -force	29,756 x <i>g</i>	23,511 x <i>g</i>
Drive Type	Brushless induction	
Time Setting	Timed up to 9 hr 59 min, pulse (short run), hold	
Accel/Decel Rates	10 accel, 10 decel	
Dimensions	37 cm (14.6 in) H x 70.7 cm (27.8 in) D x 46 cm (18.1 in) W	35.5 cm (14 in) H x 55 cm (21.7 in) D x 46 cm (18.1 in) W
Weight	75 kg (172 lb)	48 kg (106 lb)

Allegra 64R Centrifuge



The Allegra 64R takes high g-forces (up to 64,400 x g) to the lab bench. Optimal for subcellular fractionation, proteins, and viruses—you can spin from 0.25 mL to 85 mL, operate at temperatures from 2° to 40°C, and select rotors that have been BioCertified.



Allegra 64R Centrifuge and rotor

Configuration	Part Number
230V, 50Hz (EU)	367587
230V, 50Hz (UK)	367588
208V, 60Hz	367586
200V, 60Hz	367585
200V, 50Hz	367584

Specifications	
Maximum Speed	30,000 rpm
Maximum g-force	64,400 x g
Speed Control	± 50 rpm of set speed
Drive Type	Brushless induction
Time Setting	Timed up to 9 hr 59 min, pulse (short run), hold
Accel/Decel Rates	10 accel, 10 decel
Settable Temperature Range	-20° to +40°C
Operating Temperature Range	2° to +40°C
Dimensions	38 cm (15 in) H x 66 cm (26 in) D x 61 cm (24 in) W
Weight	102.1kg (225 lb)

BENCHTOP CENTRIFUGATION

Allegra X-5 Clinical Benchtop Centrifuge



The Allegra X-5 clinical air-cooled benchtop centrifuge is designed specifically for the clinical laboratory which offers high throughput for 13mm and 16mm blood tubes and additional adapters that are compatible with Beckman Coulter Diagnostic instruments (DxC, Dxl, AutoMate).



	Configuration	Part Number
IVD	220-240V, 50-60Hz	B30586
	220-240V, 50-60Hz, CCC Plug	B30588
	200V, 50-60Hz	B30587
	120V, 60Hz	B30585

Centrifuge and Rotor Sales Groups available on page 1-6.

Specifications	
Maximum Speed	4,700 rpm
Maximum <i>g</i> -force	4,470 x <i>g</i>
Drive Type	Brushless 3-phase
Time Setting	Timed up to 9 hr 59 min, pulse (short run), hold
Accel/Decel Rates	10 accel, 10 decel
Operating Temperature Range	+2° to +40°C
Dimensions	39 cm (15.3 in) H x 63.4 cm (25 in) D x 49.6 cm (19.5 in) W
Weight (without Rotor)	177 kg (169 lb)



Centrifuge and Rotor Sales Groups

Avanti J-15 & J-15R	Avanti J-15		Avanti J-15R					
	IVD	non-IVD	IVD			non-IVD		
			120V	208-230V 60Hz	200-230V 50Hz	120V	208-230V 60Hz	200-230V 50Hz
Centrifuge ONLY PN	C01994	C01995	B99517	C31547	B99515	B99516	C31546	B99514
Fixed Angle Package centrifuge + JA-10.1000 FA rotor	C19393	C19394	C19392	C38176	C19390	C19391	C38175	C19389
Swinging Bucket Package Centrifuge + JS-4.750 SW rotor	C19399	C19400	C19398	C38178	C19396	C19397	C38177	C19395
Microplate Package Centrifuge + JS-4.750u microplate rotor - microplate carriages (qty 4)	C19405	C19406	C19403	C38180	C19402	C19403	C38179	C19401
"BioSafe Package" Centrifuge + JS-4.750 SW rotor - Aerosolve canisters (qty 4) - 15mL conical tube rack (qty 4) - 50mL conical tube rack (qty 4)	C19411	C19412	C19410	C38182	C19408	C19409	C38181	C19407
Cell Culture Package Centrifuge + JS-4.750 SW rotor - 15mL conical adapter (qty 4) - 50mL conical adapter (qty 4)	C19417	C19418	C19416	C38184	C19414	C19415	C38183	C19413
Blood Sample Package Centrifuge + JS-4.750 SW rotor - 13mm tube adapter (qty 4) - 16mm tube adapter (qty 4)	C19423	C19424	C19422	C38186	C19420	C19421	C38185	C19419

Allegra X-30 & X-30R	Allegra X-30						Allegra X-30R					
	IVD			non-IVD			IVD			non-IVD		
	120V	230V	230V CCC	120V	230V	230V CCC	120V	230V	230V CCC	120V	230V	230V CCC
Centrifuge ONLY PN	B06314	B06315	B06318	A99466	A99467	A99468	B06320	B06321	B06322	A99470	A99471	A99472
Microplate SW Rotor Package centrifuge + S6096 microplate rotor	B08538	B08539	B08722	B05798	B05799	B08721	B08542	B08543	B08724	B54588	B05806	B08723
High Speed FA Rotor Package centrifuge + 24x1.5mL FA rotor	B08545	B08546	B08726	B05807	B05808	B08725	B08547	B08548	B08728	B05809	B05810	B08727
Cell Culture Package centrifuge + SX4400 SW rotor - 15mL conical adapter (qty 4) - 50mL conical adapter (qty 4)	B08536	B08537	B08716	B05794	B05795	B08715	B08540	B08541	B08718	B05800	B05801	B08717
Cell Culture Max Capacity centrifuge + SX4400 SW rotor - 15mL (9 Falcon Tubes) adapter (qty 4) - 50mL (4 Falcon Tubes) adapter (qty 4)	B08705	B08706	B08707	-	B08711	B08712	B08708	B08709	B08710	-	B08713	B08714
Blood Sample Package centrifuge + SX4400 SW rotor - 12 x 15mL tube adapter (qty 4) - 16 tube adapter (qty 4)	B05796	B05797	B08719	-	-	-	B05802	B05803	B08720	-	B05805	-

Allegra X-5	Allegra X-5
Clinical Sample Prep Package Allegra X-5 Centrifuge, 120 V 60 Hz, IVD	B30589
Clinical Sample Prep Package Allegra X-5 Centrifuge, 220-240 V 50-60 Hz, IVD	B30590
Clinical Sample Prep Package Allegra X-5 Centrifuge, 200 V 50-60 Hz, IVD	B30591
Clinical Sample Prep Package Allegra X-5 Centrifuge, 220-240 V w/CCC plug, IVD	B30592

Benchtop Centrifuges Rotor Summary

Rotor Type	Part Number	Maximum Speed (rpm)	Maximum Force (g)	Number Tubes/Bottles and Size (diameter x length) mm	Rotor Capacity (mL)	Rotor Angle	BioSafe	Avanti J-15 Series	Allegra X-30 Series	Allegra 64R	Allegra X-5
Fixed-Angle Rotors											
F1202	364630	30,000	64,400	12 x 2.0 11 x 45	24	45°	No			•	
F0630	361231	26,200	59,860	6 x 38.5 25.3 x 92	231	30°	No		•	•	
F2402H	361171	26,000	62,000	24 x 2.0 11 x 45	48	45°	Yes BIOC		•	•	
F1010	361221	26,000	57,440	10 x 10 16.1 x 81.1	100	35°	No		•	•	
F3602	364600	22,000	47,618	36 x 2.0 11 x 45	72	45°	No			•	
F0650	364610	21,000	41,400	6 x 50 29 x 104	300	25°	No			•	
F0485	364620	20,000	40,700	4 x 85 38 x 104	340	30°	No			•	
F0850	364640	16,500	28,611	8 x 50 29 x 107	400	25°	No		•	•	
F0685	364650	15,500	26,320	6 x 85 38 x 104	510	25°	No		•	•	
FX301.5	392274	14,000	21,920	30 x 2.2 1 x 45	66	45°	No		•		
JA-10.100	B77584	10,200	11,400	6 x 100 38 x 102	600	25°	Yes BIOC	•			
C1015	364680	10,000	10,400	10 x 15 17 x 120	150	25°	No		•	•	•
C0650	364670	10,000	10,400	6 x 50 28.5 x 107	300	25°	No		•	•	•
Horizontal and Swinging-Bucket Rotors											
SX241.5	392271	14,000†	16,220	24 x 2.2 11 x 45	52.8	90°	No		•		
H6002	363000	12,200	12,400	60 x 1.8 11 x 39	108	90°	Yes BIOC			•	•
S0410	364660	10,000	10,733	4 x 10 16 x 83	40	90°	No			•	•
SX4250	392243	4,500†	3,901	4 x 250 61.6 x 125	1,000	90°	No		•		
JS-4.750	B77580	4,750†	5,250	4 x 750 96 x 130	3,000	90°	Yes* BIOC	•			
S2096	361111	3,000	1,107	2 plate carriers, 6 plates, 2 deepwell	576	90°	No		•		
S6096	B01430	4,700	2,721	2 plate carriers, 6 plates, 2 deepwell	576	90°	No		•		
SX4400	B01425	4,700	4,255	4 x 400 85 x 118	1,600	90°	Yes BIOC		•		
SX4700	B30593	4,700	4,470	140 x 7 13 x 100	1,000	95°	No				•

* Biosafe covers are required for biocertification.

† In refrigerated centrifuges; maximum speed/rcf values in nonrefrigerated centrifuges are lower. Refer to Rotor Manual.

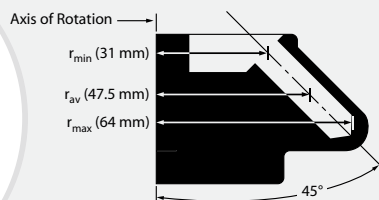

Fixed-Angle Rotor, Aluminum

Major applications: Pelleting subcellular organelles, DNA, viruses, bacteria, mitochondria, chloroplasts or algae.

Max. rpm	Max. g	k Factor	Number of Tubes Volume/Size	Rotor Capacity
30,000	64,400	204	12 x 2.0 mL 11 x 45 mm 0.44 x 1.8 in	24 mL

For use in the Allegra 64R centrifuge.

No. 364630. F1202 Fixed-Angle Rotor, for 30,000 rpm operation. Tubes and bottles not included.

Tubes										
Tube Style/Material	Nominal Volume per Tube (mL)*	Part No.	Quantity	Size (mm)	Required Adapters	Tubes per Adapter	g-Force	k Factor	Maximum Speed	
Open Top Tubes, Plain										
Polyethylene	250 µL	652823	1000	5 x 45	361247	1	9,500	----	11,500	
	400 µL	314326	1000	7 x 40	361247	1	9,500	----	11,500	
Open Top Tubes, Coated										
Polyethylene	Heparin/Lithium/Fluoride coated	652821	1000	5 x 45	361247	1	9,500	----	11,500	
	Heparin/Lithium coated	652822	1000	5 x 45	361247	1	9,500	----	11,500	
	Heparin/Lithium/Fluoride coated	652824	1000	7 x 40	361247	1	9,500	----	11,500	
	Heparin/Lithium coated	652825	1000	7 x 40	361247	1	9,500	----	11,500	
Tubes with Attached Caps										
Polypropylene	1.5	357448	500	11 x 38	364701	1	64,396	204	30,000	
Polyethylene	1.9	340196	500	11 x 39	364701	1	7,200	----	10,000	
Tubes with Separate Caps										
Polypropylene	400 µL	342867	1000	7 x 40	361247	1	9,500	----	11,500	
	1.5	343169	500	11 x 38	364701	1	64,396	204	30,000	
Tubes, Other Manufacturers										
500- to 750-µL Tubes	500 µL/ 700 µL	---	---		364690	1	---	---	11,500	

* Unless otherwise noted.

Rotor Replacement Parts

364633	Rotor Lid
961931	Rotor Lid O-ring
361367	Tie-down Screw
361371	T-handle Rotor Wrench

Adapters

361247 364701 364690



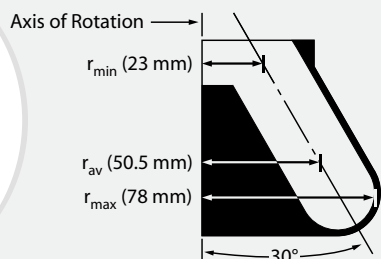

Fixed-Angle Rotor, Aluminum

Major applications: Pelleting subcellular organelles, viruses, bacteria, mitochondria, chloroplasts or algae.

Max. rpm	Max. g	k Factor	Number of Tubes Volume/Size	Rotor Capacity
26,200*	59,860	454	6 x 38.5 mL 25.3 x 92 mm 1 x 4 in	231 mL

For use in Allegra 64R and Allegra X-30 series centrifuges

No. 361231. F0630 Fixed-Angle Rotor, for 26,200 rpm* operation. Tubes and bottles not included.

Bottles and Tubes									
Tube Style/Material	Nominal Volume per Tube (mL)	Part No.	Quantity	Size (mm)	Required Adapters	Tubes per Adapter	g-Force	k Factor	Maximum Speed
Bottles with Cap Assemblies									
Polycarbonate	26.3	355616	3	25 x 89	----	----	59,860	454	26,200
Bottles with Screw Caps									
Polypropylene	30	363073	6	25.3 x 92	----	----	59,860	454	26,200
Polycarbonate	30	363070	6	25.3 x 92	----	----	59,860	454	26,200
Open Top Tubes									
Polypropylene, Thin-wall	34	326825	50	25 x 76	----	----	28,300	---	18,000
Polypropylene, Thick-wall	32	355642	25	25 x 89	----	----	59,860	454	26,200
Ultra-Clear™	38.5	344058	50	25 x 89	----	----	59,860	454	26,200

* This rotor is rated slower for the Allegra X-30 series centrifuges. See the rotor manual for specific information.

Rotor Replacement Parts

369353	Rotor Lid
961923	Rotor Lid O-ring
361367	Tie-down Screw
361371	T-handle Rotor Wrench

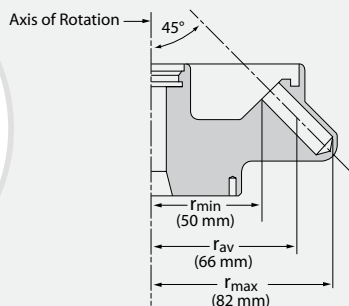

Fixed-Angle Rotor, Aluminum

Major applications: Pelleting subcellular organelles, nucleic acids, viruses, bacteria, mitochondria, chloroplasts, or algae.

Max. rpm	Max. g	k Factor	Number of Tubes Volume/Size	Rotor Capacity
26,000a	62,000	185	24 x 2.0 mL 11 x 45 mm 0.44 x 1.8 in	48 mL

For use in Allegra 64R and Allegra X-30 series centrifuges

No. 361171. F2402H Hermetically Sealed BioSafe Rotor, for 26 000 rpm* operation. Tubes and bottles not included.

Tubes										
Tube Style/Material		Nominal Volume per Tube (mL)**	Part No.	Quantity	Size (mm)	Required Adapters	Tubes per Adapter	g-Force	k Factor	Maximum Speed
Open Top Tubes, Plain										
Polyethylene		250 µL	652823	1000	5 x 45	361247	1	11,900	----	11,500
		400 µL	314326	1000	7 x 40	361247	1	11,900	----	11,500
Open Top Tubes, Coated										
Polyethylene	Heparin/Lithium/Fluoride coated	250 µL	652821	1000	5 x 45	361247	1	11,900	----	11,500
	Heparin/Lithium coated	250 µL	652822	1000	5 x 45	361247	1	11,900	----	11,500
	Heparin/Lithium/Fluoride coated	400 µL	652824	1000	7 x 40	361247	1	11,900	----	11,500
	Heparin/Lithium coated	400 µL	652825	1000	7 x 40	361247	1	11,900	----	11,500
Tubes with Attached Caps										
Polypropylene		1.5	357448	500	11 x 38	364701	1	62,084	----	20,000
Polyethylene		1.9	340196	500	11 x 39	364701	1	8,960	----	10,000
Tubes with Separate Caps										
Polypropylene		400 µL	342867	1000	7 x 40	361247	1	11,900	----	11,500
		1.5	343169	500	11 x 38	364701	1	62,084	185	26,000
Tubes, Other Manufacturers										
500- to 750-µL Tubes		500 µL/ 700 µL	--	--		364690	1	--	--	11,500

* This rotor is rated slower for the Allegra X-30 series centrifuges. See the rotor manual for specific information.

** Unless otherwise noted

Rotor Replacement Parts

974933	Rotor Lid O-ring (small)
361367	Tie-down Screw
361371	T-handle Rotor Wrench
974934	Rotor O-ring (large)
369352	Rotor Lid

Adapters

361247 | 364701



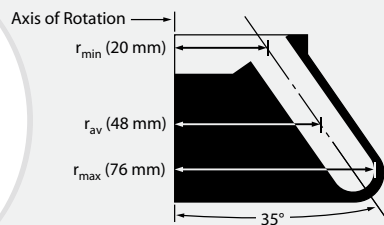

Fixed-Angle Rotor, Aluminum

Major applications: Pelleting subcellular organelles, viruses, bacteria, mitochondria, chloroplasts or algae.

Max. rpm	Max. g	k Factor	Number of Tubes Volume/Size	Rotor Capacity
26,000*	57,440	500	10 x 10 mL 16.1 x 81.1 mm 0.625 x 3 in	100 mL

For use in Allegra 64R and Allegra X-30 series centrifuges

No. 361221. F1010 Fixed-Angle Rotor, for 26,000 rpm* operation. Tubes and bottles not included.

Bottles and Tubes									
Tube Style/Material	Nominal Volume per Tube (mL)	Part No.	Quantity	Size (mm)	Required Adapters	Tubes per Adapter	g-Force*	k Factor	Maximum Speed*
Bottles with Screw Caps									
Polypropylene	10	364695	10	16.1 x 81.1	----	----	57,440	500	26,000
Polycarbonate	10	355672	25	16 x 80	----	----	57,440	500	26,000
Teflon†	10	364693	10	16.1 x 81.1	----	----	57,440	500	26,000
Tubes									
Polypropylene, Thick-wall	6.5	355646‡	25	16 x 64	----	----	----	----	26,000
	10	355640	25	16 x 76	----	----	57,440	500	26,000
Polycarbonate	6.5	355647‡	25	16 x 64	----	----	----	----	26,000
	10	355630	25	16 x 76	----	----	57,440	500	26,000
Ultra-Clear™	13.5	344085	50	16 x 76	----	----	57,440	500	26,000

* This rotor is rated slower for the Allegra X-30 series centrifuges. See the rotor manual for specific information.

† Teflon is a registered trademark of E. I. Du Pont de Nemours & Company.

‡ To facilitate tube removal, place rubber pad (part number 342602) at the bottom of the tube cavity before inserting the tube.

Rotor Replacement Parts

369351	Rotor Lid
961923	Rotor Lid O-ring
361367	Tie-down Screw
361371	T-handle Rotor Wrench

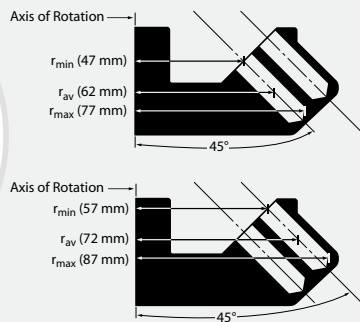

Fixed-Angle Rotor, Aluminum

Major applications: Pelleting subcellular organelles, nucleic acids, viruses, bacteria, mitochondria, chloroplasts or algae.

Max. rpm	Max. g Outer/Inner	k Factor Outer/Inner	Number of Tubes Volume/Size	Rotor Capacity
22,000	47,618/41,666	224/260	36 x 2 mL 11 x 45 mm 0.48 x 1.8 in	72 mL

For use in Allegra 64R centrifuge.

No. 364600. F3602 Fixed-Angle Rotor, for 22,000 rpm operation. Tubes and bottles not included.

Tubes									
Tube Style/Material	Nominal Volume per Tube (mL)*	Part No.	Quantity	Size (mm)	Required Adapters	Tubes per Adapter	g-Force Outer/Inner	k Factor Outer/Inner	Maximum Speed
Tubes with Attached Caps									
Polypropylene	1.5	357448	500	11 x 38	364701	1	47,618/41,666	224/260	22,000
Polyethylene	1.8	340196	500	11 x 39	364701	1	9,740/8,620	1 070/1 250	10,000
Tubes with Separate Caps									
Polypropylene	250.0 µL	342865	1000	7 x 30	361247	1	12,900/11,400	809/944	11,500
	400.0 µL	342867	1000	7 x 40	361247	1	12,900/11,400	809/944	11,500
	1.9	343169	500	11 x 38	364701		47,618/41,666	224/260	22,000
Tubes, Plain									
Polyethylene	250.0 µL	652823	1000	5 x 45	361247	1	12,900/11,400	809/944	11,500
	400.0 µL	314326	1000	7 x 40	361247	1	12,900/11,400	809/944	11,500
Tubes, Coated									
Polyethylene	250.0 µL	652821 ^a	1000	5 x 45	361247	1	12,900/11,400	809/944	11,500
	250.0 µL	652822 [†]	1000	5 x 45	361247	1	12,900/11,400	809/944	11,500
	400.0 µL	652824 ^a	1000	7 x 40	361247	1	12,900/11,400	809/944	11,500
	400.0 µL	652825 [†]	1000	7 x 40	361247	1	12,900/11,400	809/944	11,500
Tubes, Other Manufacturers									
500- to 750-µL Tubes	500 µL/ 700 µL	--	--		364690	1	--	--	11,500

- * Unless otherwise noted
- † Heparin-Lithium coated.
- a Heparin-Lithium Fluoride coated.

Rotor Replacement Parts

369354	Rotor Lid
961929	Rotor Lid O-ring
361367	Tie-down Screw
361371	T-handle Rotor Wrench
361167	Lid Screw
361168	Lid Handle

Adapters

361247 364701



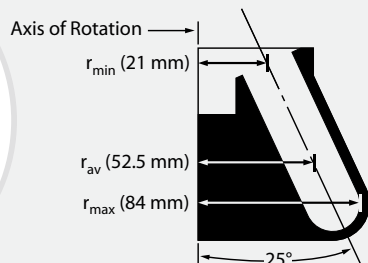

Fixed-Angle Rotor, Aluminum

Major applications: Density gradient separations of erythrocytes, cell lysate fractions and granules, as well as different separations of DNA, proteins, and viruses.

Max. rpm	Max. g	k Factor	Number of Tubes Volume/Size	Rotor Capacity
21,000	41,400	795	6 x 50 mL 29 x 107 mm 1.125 x 4.25 in	300 mL

For use in Allegra 64R centrifuge.

No. 364610. F0650 Fixed-Angle Rotor, for 21,000 rpm operation. Tubes and bottles not included.

Bottles and Tubes									
Tube Style/Material	Nominal Volume per Tube (mL)	Part No.	Quantity	Size (mm)	Required Adapters	Tubes per Adapter	g-Force	k Factor	Maximum Speed
Bottles with Cap Assemblies									
Polypropylene	50	357001	6	29 x 104	----	----	41,400	795	21,000
	50	361694	24	29 x 104	----	----	41,400	795	21,000
Polycarbonate	50	357000	6	29 x 104	----	----	41,400	795	21,000
Bottles with Screw Caps									
Polypropylene	50	357003	25	29 x 104	----	----	41,400	795	21,000
Polycarbonate	50	357002	25	29 x 104	----	----	41,400	795	21,000
Teflon [†] with High-speed Screw Cap	50	363076	8	28.5 x 107	----	----	41,400	795	21,000
Tubes									
Polycarbonate	50	363647	25	29 x 104	----	----	41,400	795	21,000
Polycarbonate, Graduated	50	363075	8	29 x 104	----	----	32,300	----	18,500
Polypropylene	50	357007	25	29 x 104	----	----	41,400	795	21,000
Tubes with Snap-On Caps									
Polycarbonate	50	363664	25	29 x 104	----	----	28,611	973	16,500
Polypropylene	50	357005	25	29 x 104	----	----	28,611	973	16,500

[†] Teflon is a registered trademark of E. I. Du Pont de Nemours & Company.

Rotor Replacement Parts

369355	Rotor Lid
961930	Rotor Lid O-ring
361367	Tie-down Screw
361371	T-handle Rotor Wrench

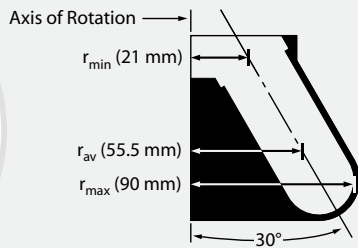

Fixed-Angle Rotor, Aluminum

Major applications: Pelleting subcellular organelles, viruses, bacteria, mitochondria, chloroplasts or algae.

Max. rpm	Max. g	k Factor	Number of Tubes Volume/Size	Rotor Capacity
20,000	40,700	920	4 x 85 mL 38 x 104 mm 1.5 x 4 in	340 mL

For use in the Allegra 64R centrifuge.

No. 364620. F0485 Fixed-Angle Rotor, for 20,000 rpm operation. Tubes and bottles not included.

Bottles and Tubes									
Tube Style/Material	Nominal Volume per Tube (mL)	Part No.	Quantity	Size (mm)	Required Adapters	Tubes per Adapter	g-Force	k Factor	Maximum Speed
Bottles with Cap Assemblies									
Polycarbonate	70	355620	6	38 x 102	342604	----	40,248	920	20,000
	85	363081	6	38 x 104	----	----	40,700	920	20,000
Bottles with Screw Caps									
Polypropylene	50*	357003	25	29 x 104	347539	1	40,248	----	20,000
Polycarbonate	50	357002	25	29 x 104	347539	1	40,248	----	20,000
Polypropylene with Special Cap	80	363082	6	38 x 104	----	----	40,700	920	20,000
Tubes									
Polypropylene, Thick-wall	81	355643†	25	38 x 102	----	----	40,700	920	20,000
Polypropylene, Thin-wall	94	345775	25	38 x 102	----	----	40,700	920	20,000
Polycarbonate	50	363647	25	29 x 104	347539	1	40,248	----	20,000
	81	355628†	25	38 x 102	----	----	40,248	920	20,000
Polypropylene	50	357007	25	29 x 104	347539	1	40,248	----	20,000

* Run with reduced fill volume to prevent spilling/leaking.

† To facilitate tube removal, place rubber pad (part number 344120) at the bottom of the tube cavity before inserting the tube.

Rotor Replacement Parts

364623	Rotor Lid
961930	Rotor Lid O-ring
361367	Tie-down Screw
361371	T-handle Rotor Wrench

Adapters

347539



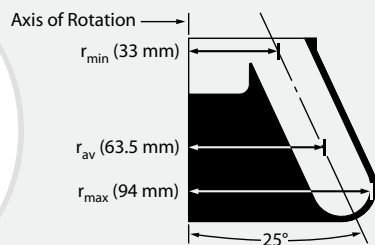

Fixed-Angle Rotor, Aluminum

Major applications: Density gradient separations of erythrocytes, cell lysate fractions and granules, as well as different separations of DNA, proteins, and viruses.

Max. rpm	Max. g	k Factor	Number of Tubes Volume/Size	Rotor Capacity
16,500*	29,220	973	8 x 50 mL 29 x 107 mm 1.125 x 4.25 in	400 mL

For use in Allegra 64R and Allegra X-30 series centrifuges

No. 364640. F0850 Fixed-Angle Rotor, for 16,500 rpm* operation. Tubes and bottles not included.

Bottles and Tubes									
Tube Style/Material	Nominal Volume per Tube (mL)	Part No.	Quantity	Size (mm)	Required Adapters	Tubes per Adapter	g-Force*	k Factor	Maximum Speed*
Bottles with Cap Assemblies									
Polypropylene	50	357001	6	29 x 104	----	----	29,220	973	16,500
	50	361694	24	29 x 104	----	----	29,220	973	16,500
Polycarbonate	50	357000	6	29 x 104	----	----	29,220	973	16,500
Bottles with Screw Caps									
Polypropylene	50	357003	25	29 x 104	----	----	29,220	973	16,500
Polycarbonate	50	357002	25	29 x 104	----	----	29,220	973	16,500
Teflon [†] with High-speed Screw Cap	50	363076	8	28.5 x 107	----	----	29,220	973	16,500
Tubes									
Polycarbonate	50	363647	25	29 x 104	----	----	29,220	973	16,500
Polycarbonate, Graduated	50	363075	8	29 x 104	----	----	17,800	1,570	13,000
Polypropylene	50	357007	25	29 x 104	----	----	28,611	973	16,500
Tubes with Snap-On Caps									
Polycarbonate	50	363664	25	29 x 104	----	----	29,220	973	16,500
Polypropylene	50	357005	25	29 x 104	----	----	29,220	973	16,500

* This rotor is rated slower for the Allegra X-30 series centrifuges. See the rotor manual for specific information.

† Teflon is a registered trademark of E. I. Du Pont de Nemours & Company.

Rotor Replacement Parts

369358	Rotor Lid
961922	Rotor Lid O-ring
361367	Tie-down Screw
361371	T-handle Rotor Wrench

Adapters

870329



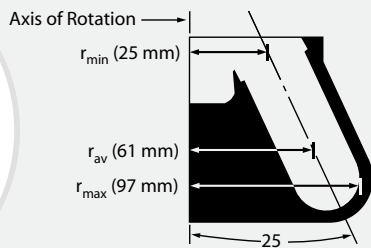

Fixed-Angle Rotor, Aluminum

Major applications: Pelleting subcellular organelles, viruses, bacteria, mitochondria, chloroplasts or algae.

Max. rpm	Max. g	k Factor	Number of Tubes Volume/Size	Rotor Capacity
15,500*	26,320	1,428	6 x 85 mL 38 x 104 mm 1.5 x 4 in	510 mL

For use in Allegra 64R and Allegra X-30 series centrifuges

No. 364650. F0685 Fixed-Angle Rotor, for 15,500 rpm* operation. Tubes and bottles not included.

Bottles and Tubes									
Tube Style/Material	Nominal Volume per Tube (mL)	Part No.	Quantity	Size (mm)	Required Adapters	Tubes per Adapter	g-Force*	k Factor	Maximum Speed*
Bottles with Cap Assemblies									
Polycarbonate	70	355620 [†]	6	38 x 102	----	----	26,320	1,428	15,500
	85	363081	6	38 x 104	----	----	26,320	1,428	15,500
Bottles with Screw Caps									
Polypropylene	50	357003	25	29 x 104	347539	1	26,320	1,428	15,500
Polycarbonate	50	357002	25	29 x 104	347539	1	26,320	1,428	15,500
Polypropylene	80	363082	6	38 x 104	----	----	26,320	1,428	15,500
	100**	355624	6	38 x 102	----	----	26,320	1,428	15,500
Tubes									
Polypropylene, Thick-wall	81	355643 [§]	25	38 x 102	----	----	26,320	1,428	15,500
Polypropylene, Thin-wall	94	345775 [§]	25	38 x 102	----	----	26,320	1,428	15,500
Polycarbonate	50	363647	25	29 x 104	347539	1	26,320	1,428	15,500
	81	355628 [§]	25	38 x 102	----	----	26,320	1,428	15,500
Polypropylene	50	357007	25	29 x 104	347539	1	26,320	1,428	15,500

* This rotor is rated slower for the Allegra X-30 series centrifuges. See the rotor manual for specific information.

† Requires adapter pad 342604.

** Run with reduced fill volume to prevent spilling/leaking.

§ To facilitate tube removal, place rubber pad (part number 344120) at the bottom of the tube cavity before inserting the tube.

Rotor Replacement Parts

364653	Rotor Lid
961929	Rotor Lid O-ring
361367	Tie-down Screw
361371	T-handle Rotor Wrench

Adapters

347539



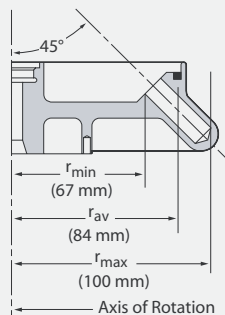

Fixed-Angle Rotor, Material

Major applications: Pelleting, subcellular organelles, nucleic acids, viruses, bacteria, mitochondria, chloroplasts or algae.

Max. rpm	Max. g	k Factor	Number of Tubes Volume/Size	Rotor Capacity
16,000*	28,672†	519	30 x 2.2 mL 11 x 45 mm 0.48 x 1.8 in	66 mL

For use in Allegra X-30 series centrifuges

No. 392274. FX301.5 Fixed-Angle Rotor Assembly. Tubes and bottles not included.

Tubes										
Tube Style/Material	Nominal Volume per Tube (mL)	Part No.	Quantity	Size (mm)	Required Adapter	Tubes per Adapter	g-Force	k Factor	Maximum Speed	
Tubes with Snap-on Caps										
Polypropylene	Natural, Attached cap	1.5	357448	500	11 x 38	---	1	---	---	14,000*
Polyethylene	Heparin-Lithium-Fluoride Coated	250.0 µL	652821	1000	5 x 45	361247	1	---	---	11,500
	Heparin-Lithium Coated	250.0 µL	652822	1000	5 x 45	361247	1	---	---	11,500
	Plain	250.0 µL	652823	1000	5 x 45	361247	1	---	---	11,500
	Heparin-Lithium-Fluoride Coated	400.0 µL	652824	1000	7 x 40	361247	1	---	---	11,500
	Heparin-Lithium Coated	400.0 µL	652825	1000	7 x 40	361247	1	---	---	11,500
	Plain	400.0 µL	314326	1000	7 x 40	361247	1	---	---	11,500
	Attached cap	1.8	340196	500	11 x 39	---	1	---	---	10,000
Polypropylene	Natural, Separate Cap	1.5	343169	500	11 x 38	---	1	---	---	14,000*
	500- to 750 µL Tubes**	500 µL/ 700 µL	---	---	---	364690	1	---	---	11,500

- * In refrigerated centrifuges; maximum speed in unrefrigerated centrifuges is 13,200 rpm.
- † In refrigerated centrifuges; g-force at r_{max} in unrefrigerated centrifuges is $19,515 \times g$.
- ‡ No adapter is required with this tube; however, adapter 364701 (pkg. of 12) can be used for proper conical support at higher speeds.
- ** Commercially available.

Rotor Replacement Parts

392275	Rotor Lid Assembly
368896	Lid O-ring
368991	Rotor O-ring
361367	Tie-down Screw
365636	T-handle Rotor Wrench

Adapters

361247



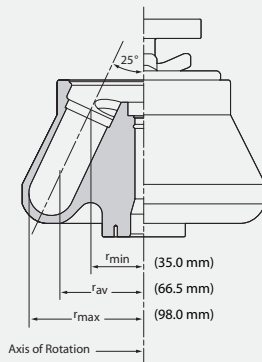

Fixed-Angle Rotor, Aluminum

Major applications: Density gradient separations of erythrocytes, cell lysate fractions and granules; differential separation of DNA, proteins, and viruses.

Max. rpm	Max. g	k Factor	Number of Tubes Volume/Size	Rotor Capacity
10,200	11,400	2507	6 x 100 mL 38 x 102 mm 1.5 x 4 in	600mL

For use in Avanti J-15 series centrifuges

No. B77584. JA-10.100 Fixed-Angle Biosafe Rotor.

Bottles and Tubes									
Tube Style/Material	Nominal Volume per Tube (mL)	Part No.	Quantity	Size (mm)	Required Adapters	Tubes per Adapter	g-Force	k Factor	Maximum Speed
Bottles with Screw Caps									
Polypropylene	50	357003	25	29 x 104	392830	1	10,907	1470	10,200
Polycarbonate	50	357002	25	29 x 104	392830	1	10,907	1470	10,200
Polypropylene	80	363082	6	38 x 104	---	---	11,419	1300	10,200
	100	355624	6	38 x 102	---	---	11,419	2000	10,200
Bottles with Cap Assemblies									
Polycarbonate	70	355620	6	38 x 102	---	---	11,419	1277	10,200
	85	363081	6	38 x 104	---	---	11,419	1358	10,200
Tubes with Snap-on Caps									
Polypropylene	1.5	357448	500	11 x 38	344497**	3	10,755	489	10,200
Polyethylene	1.9	340196	500	11 x 39	344497**	3	10,755	489	10,000
Polypropylene	1.5	343169	500	11 x 38	344497**	3	10,755	489	10,200
Tubes									
Polypropylene, Thick-wall	94	355643*	25	38 x 102	---	---	11,419	2000	10,200
Polypropylene	10	355640	25	16 x 76	392824	1	10,126	1136	10,200
Polycarbonate	10	355630	25	16 x 76	392824	1	10,126	1136	10,200
	15	342080	100	18 x 98	392823	1	10,219	1411	10,200
	50	363647	25	29 x 104	392830	1	10,907	1470	10,200
	50	363075	8	29 x 104	392830	1	10,907	1470	10,200
	94	355628*	25	38 x 102	---	---	11,419	2000	10,200
Polyethylene	15	342081	100	18 x 98	392823	1	10,219	1411	10,200
Polypropylene	15	342082	100	18 x 98	392823	1	10,219	1411	10,200
	50	357007	25	29 x 104	392830	1	10,907	1470	10,200

* To facilitate tube removal, place rubber pad (part number 344120) at the bottom of the tube cavity before inserting the tube.

** Can be double stacked to be used inside 392830.

Rotor Replacement Parts	
B77586	Lid Assembly
870612	Large O-ring
010179	Small O-ring

Table 1. Bottle and Tube Adapters for the JA-10.100 Rotor^a

Adapter Part No. (set of 6)	Tube or Bottle Type ^b	Tube Dimensions (mm)	Nominal Tube Volume (ml)	R _{max} (mm)	RCF _{max}
392830	round-bottom tube or bottle	29 x 108	50	93.6	10,907
392268	conical tube	30 x 115	50	91.9	10,709
392823	bottle	18 x 107	15	87.7	10,219
392270	conical tube	17 x 120	15	88.7	10,336
392824	round-bottom bottle	16 x 82	10	86.9	10,126
344497 ^c	microfuge tube	11 x 39	1.5	92.3	10,755

a Unless otherwise indicated, adapters are polypropylene.
 b Observe manufacturer's recommendations for RCF and temperature limitations.
 c 344497 fits in 392830.

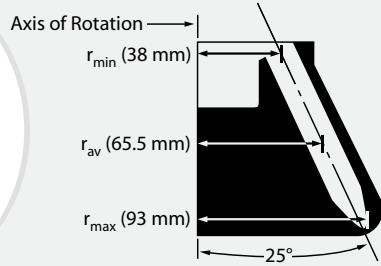

Fixed-Angle Rotor, Aluminum

Major applications: Pelleting of subcellular organelles, viruses, bacteria, mitochondria, chloroplasts or algae.

Max. rpm	Max. g	k Factor	Number of Tubes Volume/Size	Rotor Capacity
10,000*	10,400	2,270	10 x 15 mL 17 x 120 mm 0.65 x 4.75 in	150 mL

For use in Allegra 64R and Allegra X-30 Series centrifuges.

No. 364680. C1015 Fixed-Angle Rotor, for 10,000 rpm* operation. Tubes and bottles not included.†

Tubes									
Tube Style/Material	Nominal Volume per Tube (mL)	Part No.	Quantity	Size (mm)	Required Adapters	Tubes per Adapter	g-Force	k Factor	Maximum Speed
Tubes									
Conical†	15	---	---	17 x 120	---	---	10,400	2,270	10,000

* This rotor is rated slower for the Allegra X-30 series centrifuges. See the rotor manual for specific information.

† Tubes available from scientific supply vendors.

Rotor Replacement Parts	
364683	Rotor Lid
961932	Rotor Lid O-ring
361367	Tie-down Screw
361371	T-handle Rotor Wrench

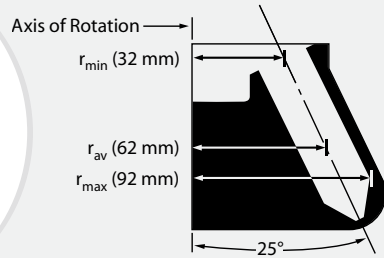

Fixed-Angle Rotor, Aluminum

Major applications: General pelleting of cells, bacteria and food products; separation of proteins, viruses and subcellular fractions; phase separation; and binding studies.

Max. rpm	Max. g	k Factor	Number of Tubes Volume/Size	Rotor Capacity
10,000*	10,400	2,680	6 x 50 mL 28.5 x 107 mm 1.125 x 4.25 in	300 mL

For use in Allegra 64R and Allegra X-30 Series centrifuges.

No. 364670. C0650 Fixed-Angle Rotor, for 10,000 rpm* operation. Tubes and bottles not included.†

Tubes									
Tube Style/Material	Nominal Volume per Tube (mL)	Part No.	Quantity	Size (mm)	Required Adapters	Tubes per Adapter	g-Force*	k Factor	Maximum Speed*
Tubes									
Conical†	50	---	---	28.5 x 107	---	---	10,400	2 680	10,000

* This rotor is rated slower for the Allegra X-30 series centrifuges. See the rotor manual for specific information.

† Tubes available from scientific supply vendors.

Rotor Replacement Parts

369360	Rotor Lid
961922	Rotor Lid O-ring
361367	Tie-down Screw
361371	T-handle Rotor Wrench

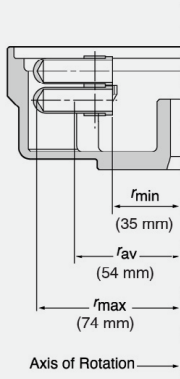

Swinging-Bucket Rotor, Aluminum

Major applications: Pelletting subcellular organelles, viruses, bacteria, mitochondria, chloroplasts or algae.

Max. rpm	Max. g	k Factor	Number of Tubes Volume/Size	Rotor Capacity
14,000*	16,244†	968	24 x 2.2 mL 11 x 45 mm 0.44 x 1.8 in.	52.8 mL

For use in Allegra X-30 Series centrifuges

No. 392271. SX241.5 Swinging-Bucket BioSafe Rotor Assembly.

Tube Style/Material		Nominal Volume per Tube (mL) [§]	Part No.	Quantity	Size (mm)	Required Adapters	Tubes per Adapter	g-Force	k Factor	Maximum Speed
Polypropylene	Natural, Attached cap	1.5	357448	500	11 x 38	---	1	---	---	14,000*
Polyethylene	Heparin-Lithium-Fluoride Coated	250.0 µL	652821	1000	5 x 45	361247	1	---	---	11,500
	Heparin-Lithium Coated	250.0 µL	652822	1000	5 x 45	361247	1	---	---	11,500
	Plain	250.0 µL	652823	1000	5 x 45	361247	1	---	---	11,500
	Heparin-Lithium-Fluoride Coated	400.0 µL	652824	1000	7 x 40	361247	1	---	---	11,500
	Heparin-Lithium Coated	400.0 µL	652825	1000	7 x 40	361247	1	---	---	11,500
	Plain	400.0 µL	314326	1000	7 x 40	361247	1	---	---	11,500
	Attached cap	1.9	340196	500	11 x 39	---	1	---	---	10,000
Polypropylene	Natural, Separate Cap	1.5	343169	500	11 x 38	---	1	---	---	14,000*
500- to 750-µL Tubes [†]		500.0 µL/ 700.0 µL	---	---		364690	1	---	---	11,500

- * In refrigerated centrifuges; maximum speed in unrefrigerated centrifuges is 12,500 rpm.
- † In refrigerated centrifuges; g-force at r_{max} in unrefrigerated centrifuges is 12,950 x g.
- ‡ No adapter is required with this tube; however, adapter 364701 (pkg. of 12) can be used.
- ** Commercially available.
- § Unless otherwise noted

Rotor Replacement Parts	
368883	Rotor Lid Assembly
368888	O-ring
368887	Bucket (set of 2)
365806	Tie-down Screw
365636	T-handle Rotor Wrench

Adapters

361247



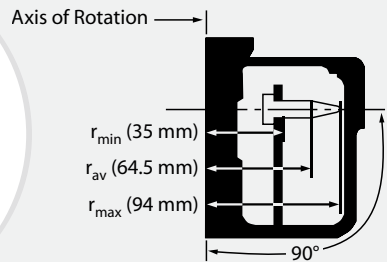

Horizontal (Bowl) Rotor, Aluminum

Major applications: Pelleting subcellular organelles, viruses, bacteria, mitochondria, chloroplasts, or algae.

Max. rpm	Max. g	k Factor	Number of Tubes Volume/Size	Rotor Capacity
12,200	12,400	1,680	60 x 1.8 mL 11 x 39 mm 0.44 x 1.5 in	108 mL

For use in the Allegra 64R centrifuge.

No. 363000. H6002 Horizontal BioSafe Rotor, for 12,200 rpm operation. Tubes and bottles not included.

Tubes										
Tube Style/Material	Nominal Volume per Tube (mL) [§]	Part No.	Quantity	Size (mm)	Tube Holder Color & Part No. [†] Set of 2/Set of 6	Tubes per Holder	g-Force	k Factor	Maximum Speed [‡]	
Tubes with Attached Caps										
Polypropylene	1.5	357448	500	11 x 38	blue 345527/345524	10	12,400	----	12,200	
Polyethylene	1.9	340196	500	11 x 39	blue 345527/345524	10	8,320	----	10,000	
Tubes										
Microtainer**	600 µL	----	----	----	red 345526 red 345522[†]	12 12	12,300	----	12,200	
Polypropylene	400 µL	342867	1000	7 x 40	dark green 345525 dark green 345521[†]	14 14	11,600	----	12,200	
	500.0 µL	344319	500	8 x 28	red 345526 red 345522[†]	12 12	9,950	----	12,200	
	1.5	343169	500	11 x 38	blue 345527/345524	10	12,400	----	12,200	
Plain Tubes										
Polyethylene	250 µL	652823	1000	5 x 45	dark green 345525 dark green 345521[†]	14 14	7,895	----	11,500	
	400 µL	314326	1000	7 x 40	dark green 345525 dark green 345521[†]	14 14	7,820	----	10,000	
Coated Tubes										
Polyethylene	Yellow	250 µL	652821	1000	5 x 45	dark green 345525 dark green 345521[†]	14 14	7,900	----	11,500
Polyethylene	Blue	250 µL	652822	1000	5 x 45	dark green 345525 dark green 345521[†]	14 14	7,900	----	11,500
Polyethylene	Yellow	400 µL	652824	1000	7 x 40	dark green 345525 dark green 345521[†]	14 14	10,300	----	11,500
Polyethylene	Blue	400 µL	652825	1000	7 x 40	dark green 345525 dark green 345521[†]	14 14	10,300	----	11,500

[†] Bold numbers feature 30° resting angle to minimize remixing of loose pellets upon completion of run.

[‡] Based on empirical tests of tube strength with the lid in place on the rotor.

** Microtainer is a registered trademark of Becton, Dickinson and Company; available commercially.

[§] Unless otherwise noted.

Rotor Replacement Parts

363002	Rotor Lid
363003	Rotor Lid Knob
344658	Rotor Lid O-ring
344659	Rotor O-ring
361367	Tie-down Screw
361371	T-handle Rotor Wrench

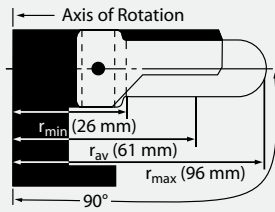

Swinging-Bucket Rotor, Anodized Aluminum

Major applications: Rapid sedimentation of protein precipitates, large particles, cells and cell debris: and for separations using gradients.

Max. rpm	Max. g	k Factor	Number of Tubes Volume/Size	Rotor Capacity
10,000	10,733	3,310	4 x 10 mL 16 x 83 mm 0.65 x 3.25 in	40 mL

For use in the Allegra 64R centrifuge.

No. 364660. S0410 Swinging-Bucket Rotor Assembly, for 10,000 rpm operation. Tubes and bottles not included.

Bottles and Tubes									
Tube Style/Material	Nominal Volume per Tube (mL)	Part No.	Quantity	Size (mm)	Required Adapters	Tubes per Adapter	g-Force	k Factor	Maximum Speed
Bottle with Cap Assembly									
Polycarbonate	10	355672	25	16 x 80	----	----	10,733	3,310	10,000
Bottles with Screw Caps									
Polypropylene	10	364695	10	16.1 x 81.1	----	----	10,733	3,310	10,000
Teflon*	10	364693	10	16.1 x 81.1	----	----	10,733	3,310	10,000
Tubes									
Polypropylene, Thick-wall	6.5	355646†	25	16 x 64	----	----	----	----	10,000
	10	355640	25	16 x 76	----	----	10,733	3,310	10,000
Polycarbonate	8	355647†	25	16 x 64	----	----	----	----	10,000
	10	355630	25	16 x 76	----	----	10,733	3,310	10,000
Ultra-Clear™	13.5	344085	50	16 x 76	----	----	10,733	3,310	10,000

* Teflon is a registered trademark of E. I. Du Pont de Nemours & Company.

† To facilitate tube removal, place rubber pad (part number 344120) at the bottom of the tube cavity before inserting the tube.

Rotor Replacement Parts	
364633	Buckets (set of 4)
361367	Tie-down Screw
361371	T-handle Rotor Wrench

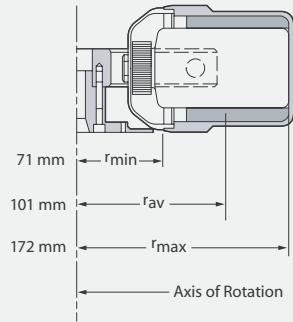

Swinging-Bucket Rotor, Aluminum

Major applications: Rapidly sediments protein precipitates, large particles, cells and cell debris. Can also be used for binding studies and for separating serum from whole blood.

Max. rpm	Max. g	k Factor	Number of Tubes Volume/Size	Rotor Capacity
4,500*	3,901†	11,070	4 x 250 mL 61.8 x 125 mm 2.5 x 5 in	1000 mL

For use in Allegra X-30 Series centrifuges.

No. 392243. SX4250 Swinging-Bucket Rotor. Unshielded, four-place rotor with aluminum rotor yoke and removable aluminum swinging buckets, all anodized black for corrosion protection. Includes four buckets without covers.

Bottles and Tubes					
Tube Style	Nominal Volume per Tube (mL)	Size (mm)	Required Adapter (set of 2)	Tubes per Adapter	Maximum Number of Tubes per Rotor
Microfuge/PCR Tubes	0.5	7 x 19	368471	24	96
Hemolyse or RIA Tubes	1.5/2.2	11 x 38	368470	16	64
	5	12 x 75	392263	25	100
	5	12 x 75	368467	16	64
Vacutainer	5	13 x 75	368467	16	64
Glass	7	12 x 100	368469	16	64
Vacutainer	10	16 x 100	368465	12	48
Monovettes	10	17	368465	12	48
Round-Bottom	10	16.1 x 81.1	368468	12	48
	10/15	17 x 110	368465	12	48
Conical	15	17 x 120	392257	5	20
Glass with Open-Top or Screw-on Cap	25	24 x 100	368463	5	20
Round-Bottom	50	28.5 x 107	368477	4	16
Conical	50	28.5 x 100	392258	3	12
Glass	50	34 x 100	392265	3	12
	80/100	44 x 100	368459	1	4
85 mL Oakridge	94	38 x 112	392261	1	4
Flat-bottom with Screw-on Cap	125	50.5 x 99	368458	1	4
	180	56.5 x 113	368457	1	4
	250	61.8 x 125	392256	1	4

* In refrigerated centrifuges; maximum speed in unrefrigerated centrifuges is 4,200 rpm.

† In refrigerated centrifuges; g-force at r_{max} in unrefrigerated centrifuges is 3,398 x g.

Replacement Parts

392266	Bucket Covers (set of 4)
392251	Bucket with Cover (set of 2)
392621	Bucket O-ring (set of 4)
361367	Tie-down Screw
365636	T-handle Rotor Wrench

Adapters										
368457	368458	368459	368463	368465	368467	368468	368469	368470	368471	368477

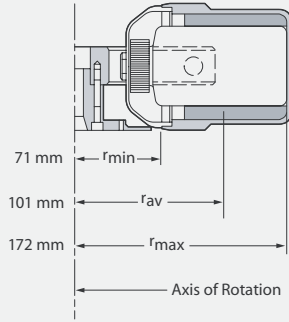

Swinging-Bucket Rotor, Aluminum

Major applications: Rapidly sediments protein precipitates, large particles, cells and cell debris. Can also be used for binding studies and for separating serum from whole blood.

Max. rpm	Max. g	k Factor	Number of Tubes Volume/Size	Rotor Capacity
4,700*	4,255†	10,146	4 x 400 85 x 118 3.35 x 4.65	1600mL

For use in Allegra X-30 Series centrifuges.

No. B01425. X4400 BioSafe Rotor Assembly. Unshielded, four-place rotor with aluminum rotor yoke and removable aluminum swinging buckets, all anodized black for corrosion protection, include four buckets without covers.

Bottles and Tubes					
Tube Style	Nominal Volume per Tube (mL)	Size (mm)	Required Adapter (set of 2)	Tubes per Adapter	Maximum Number of Tubes per Rotor
Microfuge/PCR Tubes	0.5	7 x 19	368471	24	96
Hemolyse or RIA Tubes	1.5/2.2	11 x 38	368470	16	64
	5	12 x 75	392263	25	100
	5	12 x 75	368467	16	64
Vacutainer	5	13 x 75	368467	16	64
Conical	5	17 x 56	C16283	10	40
Glass	7	12 x 100	368469	16	64
Vacutainer	10	16 x 100	368465	12	48
Monovettes	10	17	368465	12	48
Round-Bottom	10	16.1 x 81.1	368468	12	48
	10/15	17 x 110	368465	12	48
Conical	15	17 x 120	392257	5	20
Glass with Open-Top or Screw-on Cap	25	24 x 100	368463	5	20
Round-Bottom with Screw-on Cap	30	26 x 100	368462	5	20
Round-Bottom	50	28.5 x 107	368477	4	16
Conical	50	28.5 x 100	392258	3	12
	50	34 x 100	392265	3	12
Glass	80/100	44 x 100	368459	1	4
	94	38 x 112	392261	1	4
85 mL Oakridge	94	38 x 112	392261	1	4
Flat-bottom with Screw-on Cap	125	50.5 x 99	368458	1	4
	180	56.5 x 113	368457	1	4
	250	61.8 x 125	392256	1	4
Polypropylene Bottle PN: B01435	400	85 x 118	-	-	-

* In refrigerated centrifuges; maximum speed in unrefrigerated centrifuges is 4,200 rpm.

† In refrigerated centrifuges; g-force at r_{max} in unrefrigerated centrifuges is 3,398 x g.

Replacement Parts

392266	Bucket Covers (set of 4)
392251	Bucket with Cover (set of 2)
392621	Bucket O-ring (set of 4)
361367	Tie-down Screw
365636	T-handle Rotor Wrench

Adapters										
368457	368458	368459	368463	368465	368467	368468	368469	368470	368471	368477

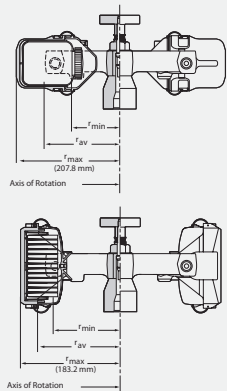

Swinging-Bucket Rotor, Stainless Steel/Aluminum

Major applications: Rapid sedimentation of protein precipitates, large particles, cells and cell debris.

Max. rpm	Max. g	Number of Tubes Volume/Size	Rotor Capacity
4,750 [†]	5,250 [†]	4 x 750 mL 96 x 130 mm 3.85 x 5.25 in	3000 mL

For use in Avanti J-15 Series centrifuges.

No. B77580. JS-4.750 Swinging-Bucket BioSafe[®] Rotor. Four-place rotor with stainless-steel rotor yoke and removable aluminum swinging buckets. Buckets are interchangeable with JS-4.750 BioSafe Microplate Carriers 392806 for spinning microtiter plates or microfuge tubes using rack inserts.

BioSafe[®] Bucket Covers

No. 392805. Set of two. Transparent bucket covers for JS-4.750 round rotor buckets to contain broken tubes.

JS-4.750 rotor shown with BioSafe Bucket Covers



Aerosolve[®] Cannisters

No. 359232. Set of four.

No. 359481. Set of two.

Aerosolve Cannisters fit in JS-4.750 round rotor buckets. These Biosafety cannisters feature an O-ring seal and are completely transparent so a broken tube can be seen and proper precautions taken before you break the seal. Cannisters can also be used as 500 mL wide-mouth bottles. Specially designed adapters accommodate most popular tubes within the cannister. **In the Tubes and Bottles chart following, adapters required for the use of tubes within Aerosolve Cannisters are listed in bold type.**



Cell Culture Flask Adapters

No. 369292. Accommodate Corning[†] 75 cm² Canted-Neck Cell Culture Flasks (PN 430641). One flask per adapter. 3,024 rpm; 2,080 x g. Orange.

No. 369295. Accommodate Corning 25 cm² Canted-Neck Cell Culture Flasks (PN 430639). Two flasks per adapter. 3,200 rpm; 2,000 x g. Green.



JS-4.750μ Microplate Carrier Rotor

No. B83980. JS-4.750μ Microplate Carrier Assembly. Includes carriage 392873 and rubber pad to cushion plates. Each carrier can hold up to 4 microplates, 1 deep-well/square well plate, 1 rack of MiniTubes, or other labware in 96-well format. Set of 2. Maximum allowable speed in Avanti J-15R is 4,450 rpm (4,060 x g), in Avanti J-15 maximum allowable speed is 4,350RPM (3,880 x g).



Rotor shown with optional biosafe covers

Replacement Parts for JS-4.750

392804	Bucket (set of 2)
392805	Bucket covers (set of 2)
961648	Replacement bucket O-ring (pkg/8)
360587	Bucket cover latch assembly

Replacement Parts for JS-4.750μ Microplate Carriers

393070	Biocertified cover for JS-4.750μ microplate carriers
392812	Replacement cover gasket (set of 4)
392873	Replacement carriage, includes rubber pad (set of 2)
392872	Replacement rubber pad for carriage (set of 4)

¹ Rotor is biocertified when used with biosafe covers.
^{*} With sealed bucket covers.
[§] Rated at 4550 rpm/4,820 x g in Avanti J-15 and J-15R 120V centrifuges
[†] Corning is a trademark of Corning Incorporated.

Bottles and Tubes									
Tube Style/Material	Nominal Volume per Tube (mL)	Part No.	Quantity	Size (mm)	Required Modular Disk Adapters Set of 2/Set of 4	Tubes per Adapter	g-Force*	k Factor	Maximum Speed*
Bottles, Wide-mouth									
Polycarbonate	250	358275	6	62 x 122	349946	1	5,250	---	4,750
Polypropylene	500	355650	6	69 x 159	349945	1	5,250	---	4,750
Polypropylene	250	358326	6	62 x 120	349946	1	5,250	---	4,750
Bottles with Cap Assemblies									
Polypropylene	50	357001	6	29 x 104	359474/359153	7	5,250	---	4,750
	50	361694	24	29 x 104	359486/359164 [†]	4	5,250	---	4,750
					359474/359153	7			
Polycarbonate	50	361693	24	29 x 104	359486/359164 [†]	4	5,250	---	4,750
					359474/359153	7			
Polycarbonate, Wide-mouth	250	356013	6	62 x 122	349946	1	5,250	---	4,750
Polypropylene, Wide-mouth	250	356011	6	62 x 122	349946	1	5,250	---	4,750
	500	355607	6	69 x 160	349945	1	5,250	---	4,750
Bottles with Screw Caps									
Polypropylene	50	357003	25	29 x 104	359474/359153	7	5,250	---	4,750
Polycarbonate	50	357002	6	29 x 104	359486/359164 [†]	7	5,250	---	4,750
					359474/359153	1			
					349946				
Polypropylene	750	358299	6	96 x 130	349846	1	5,250	---	4,750
					356855	6			
Polypropylene, Wide-mouth	500	355665	6	69 x 159	349945	1	5,250	---	4,750
Teflon with High-Speed Cap	50	363076	8	28.5 x 107	359474/359153	7	5,250	---	4,750
					359486/359164 [†]	4			

1 Rotor is biocertified when used with biosafe covers.
 * Rated at 4550 rpm/4,820 x g in Avanti J-15 and J-15R 120V centrifuges.
 † Adapters required for the use of tubes within Aerosolve® Cannisters are listed in bold type.

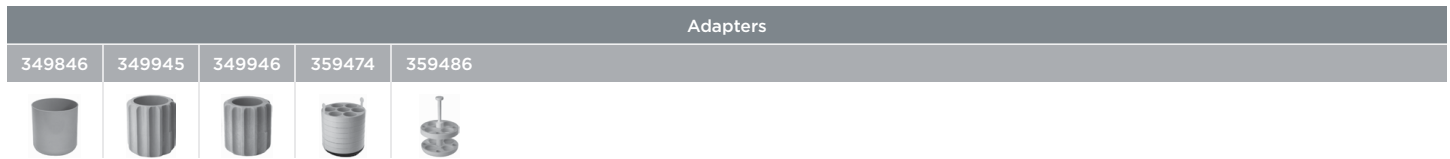

Bottles and Tubes									
Tube Style/Material	Nominal Volume per Tube (mL)	Part No.	Quantity	Size (mm)	Required Modular Disk Adapters Set of 2/Set of 4	Tubes per Adapter	g-Force*	k Factor	Maximum Speed*
Open-Top Tubes									
Polypropylene, Thick-wall	10	355640	25	16 x 76	359471/359150 359484/359162 †	19 10	5,250	---	4,750
Polyethylene	15	342081	100	18 x 98	359473/359152	14	5,250	---	4,750
Polycarbonate	10	355630	25	16 x 76	359471/359150 359484/359162 †	19 10	5,250	---	4,750
	15	342080	100	18 x 98	359473/359152	14	5,250	---	4,750
	50	363647	25	29 x 103	359474/359153 359486/359164 †	7	5,250	---	4,750
Polycarbonate, Graduated	50	363075	8	29 x 104	359474/359153 359486/359164 †	7	5,250	---	4,750
Polypropylene	15	342082	100	18 x 98	359473/359152	14	5,250	---	4,750
	50	357007	25	29 x 103	359474/359153 359486/359164 †	7	5,250	---	4,750
Tubes with Snap-On Caps									
Polypropylene	1.5	357448	500	11 x 38	359469/359148‡ 354495/--- †	37 24	5,250	---	4,750
Polycarbonate	50	363664	25	29 x 103	359474/359153 359486/359164 †	7	5,250	---	4,750
Polycarbonate, Conical	230	356987	6	62 x 141	---/356983**	1	5,250	---	4,750
Polyethylene	1.8	340196	500	11 x 39	359469/359148‡ 354495/--- †	37 24	5,250	---	4,750
Polypropylene, Conical	230	356989	6	62 x 141	349946 (ea) / 356983 ---/356985 †	1	5,250	---	4,750

1 Rotor is biocertified when used with biosafe covers.
 * Rated at 4550 rpm/4,820 x g in Avanti J-15 and J-15R 120V centrifuges.
 † Adapters required for the use of tubes within Aerosolve Cannisters are listed in bold type.
 ‡ Requires 1.5-mL adapter plate PN 354511.
 ** Requires adapter PN 349946, available 1 each pack.



Bottles and Tubes									
Tube Style/Material	Nominal Volume per Tube (mL)	Part No.	Quantity	Size (mm)	Required Modular Disk Adapters Set of 2/Set of 4	Tubes per Adapter	g-Force*	k Factor	Maximum Speed*
Tubes with Snap-On Caps (cont'd)									
Polypropylene	50	357005	25	29 x 103	359474/359153	7	5,250	---	4,750
Orange	1.5	356094	500	11 x 38	359486/359164 †	37	5,250	---	4,750
Yellow	1.5	356093	500	11 x 38	359469/359148†	37	5,250	---	4,750
Green	1.5	356092	500	11 x 38	354495/ --- †	37	5,250	---	4,750
Blue	1.5	356091	500	11 x 38	359469/359148†	37	5,250	---	4,750
Natural	1.5	356090	500	11 x 38	354495/ --- †	37	5,250	---	4,750
Natural**	1.5	343169	500	11 x 38	359469/359148†	37	5,250	---	4,750
BioVials									
Polypropylene	4	566353	1,000	14 x 55	359470/359149	24	5,250	---	4,750
					344517/ --- †				

Modular Disk Adapters (polypropylene)							
Color Code	Nom. Tube Vol. (mL)	Nom. Tube Dia. (mm)	Max. No. Tubes per Adapter	Max. No. Tubes in Rotor	Adapter Part No.		
					Set of Two	Set of Four	
Blue	3	10	37	148	359469	359148	
	5	12					
Tan	3 & 5	13	30	120	359478	359157	
Orange	7 & 10	14	24	96	359470	359149	
Purple	12	16	19	76	359471	359150	
Green (conical)	15	18	14	56	359472	359151	
Green	15 & 20	18	14	56	359473	359152	
Lt. Green (conical)	30 & 50	30	4	16	359475	359154	
Yellow	50	29	7	28	359474	359153	
Dk. Blue	50	35	4	16	359476	359155	

Blood-Bag Cups

No. 356856. Yellow cup with inner diameter of 90 mm for single- or double-packs.

No. 356857. Orange cup with inner diameter of 97 mm for triple- or quad-packs.



Rotor Supplies







392804	Round Bucket (set of 2)
392805	Round Bucket Cover (set of 2)
961648	Round Bucket O-ring (pkg of 8)
360587	Round Bucket Cover Latch Assembly
368148	Bucket Cover Air-Vent Filter (pkg of 60)

¹ Rotor is biocertified when used with biosafe covers.

* Rated at 4550 rpm/4,820 x g in Avanti J-15 and J-15R 120V centrifuges.

† Adapters required for the use of tubes within Aerosolve Cannisters are listed in bold type.

‡ Requires 1.5-mL adapter plate PN 354511, sold individually.

Adapters						
344517	349946	354495	359469	359470	359474	359486
						

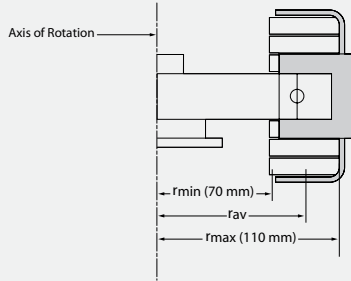

Swinging-Bucket Rotor (Unshielded), Anodized Aluminum

Major applications: Serial dilution of small liquid volumes.

Max. rpm	Max. g	Number of Plates Volume/Size
3,000	1,110	2 x 96 wells

For use in Allegra X-30 Series centrifuges.

No. 361111. S2096 Microtiter Rotor Assembly, for 3,000 rpm operation. Unshielded, two-place rotor, designed to accommodate 96-well and deep-well microplates. Racks are available that accommodate 1 mL MiniTubes.

Microplates					
No. of Wells	Description	Part No.	Quantity	g-Force	Maximum Speed
96	Multiwell (300-µL/well) Polystyrene titer plate, nonsterile	609844	100/pkg	1,110	3,000
96	Deep-well (1-mL/well) Polystyrene Titer Plates, nonsterile	267001	24/pkg	1,110	3,000
96	Deep-well (1-mL/well) Polystyrene Titer Plates, sterile	267004	24/pkg	1,110	3,000
96	Deep-well (1-mL/well) Polypropylene Titer Plates, nonsterile	267006	24/pkg	1,110	3,000
96	Deep-well (1-mL/well) Polypropylene Titer Plates, sterile	267007	24/pkg	1,110	3,000
96	Square-well (2-mL/well) Polypropylene Titer Plates	140504	24/pkg	1,110	3,000

- Accessories for Microplates**
- No. 267002.** Caps for 96-well Deep-well Titer Plates, Nonsterile (12/pkg)
 - No. 267005.** Caps for 96-well Titer Plates, Sterile (12/pkg)
 - No. 53619.** Aluminum foil lid for 96-well Deep-well Titer Plates (100/pkg)

- Rotor Replacement Parts**
- 361367 Tie-down Screw
 - 361371 T-handle Rotor Wrench

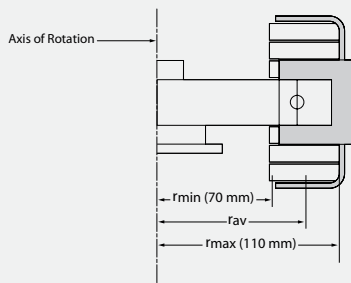

Swinging-Bucket Rotor (Unshielded), Anodized Aluminum

Major applications: Serial dilution of small liquid volumes.

Max. rpm	Max. g	Number of Plates Volume/Size
4,700	2,721	2 x 96 wells

For use in Allegra X-30 Series centrifuges.

No. B01430. S6096 Rotor Assembly. Unshielded, two-place rotor, designed to accommodate 96-well microplates. Racks available that accommodate 1mL Minutubes.

Microplates					
No. of Wells	Description	Part No.	Quantity	g-Force	Maximum Speed
96	Multiwell (300- μ L/well) Polystyrene titer plate, nonsterile	609844	100/pkg	2,721	4,700
96	Deep-well (1-mL/well) Polystyrene Titer Plates, nonsterile	267001	24/pkg	2,721	4,700
96	Deep-well (1-mL/well) Polystyrene Titer Plates, sterile	267004	24/pkg	2,721	4,700
96	Deep-well (1-mL/well) Polypropylene Titer Plates, nonsterile	267006	24/pkg	2,721	4,700
96	Deep-well (1-mL/well) Polypropylene Titer Plates, sterile	267007	24/pkg	2,721	4,700
96	Square-well (2-mL/well) Polypropylene Titer Plates	140504	24/pkg	2,721	4,700

Accessories for Microplates

- No. 267002.** Caps for 96-well Deep-well Titer Plates, Nonsterile (12/pkg)
- No. 267005.** Caps for 96-well Titer Plates, Sterile (12/pkg)
- No. 53619.** Aluminum foil lid for 96-well Deep-well Titer Plates (100/pkg)

Rotor Replacement Parts

- 361367 Tie-down Screw
- 361371 T-handle Rotor Wrench
- B01431 Bucket with carriers (set of 2)
- B01432 Carrier (set of 2)

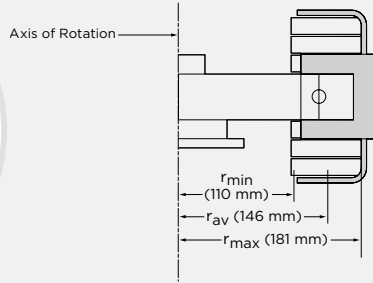

Swinging-Bucket Rotor, Anodized Aluminum

Major Applications: Whole blood serum and plasma separation.

Max. rpm	Max. g	Number of Tubes Volume/Size	Rotor Capacity
4,700	4,470	100 x 10	1000mL

For use in Allegra X-5 centrifuge.

No. B30593. SX4700 Rotor Assembly.

Tube Adaptors				
Description	Nominal Volume	Adapter PN (qty 2)	Tube per Adapter	Maximum Number Tubes per Rotor
5/7 mL blood collection tubes	5/7 mL	B30602	35	140
10 mL blood collection tubes	10 mL	B30603	25	100
Beckman DxC/DxI 4-place 13/16 mm tube sample racks	Varies	B30604	4 racks 16 tubes	16 racks 64 tubes
Adapter for Beckman Coulter AutoMate 2500 Family, 13mm tubes	5/7 mL	B32766	25	100
Adapter for Beckman Coulter AutoMate 2500 Family, 17mm tubes	10 mL	B32767	16	64

Rotor Replacement Parts	
B30718	Buckets (set of 2)
B31136	Tie-down screw
368246	T-handle rotor wrench

Microfuge 16 Microcentrifuge



The Microfuge 16 is fast and powerful—for optimal pelleting on the bench or in the cold room. Perfect for DNA, RNA, proteins, and virus cell isolation. Its maintenance-free motor spins up to 14,800 rpm (16,163 x g). Easy-to-read interface displays both speed (rpm) and force (rcf). Select timed, hold, or pulse (short) run times.



Microfuge 16 Microcentrifuge

Configuration	Part Number
100/120 V, 50/60 Hz, with FX241.5P rotor	A46472
220/240 V, 50/60 Hz, with FX241.5P rotor	A46471
100/120 V, 50/60 Hz	A46474
220/240 V, 50/60 Hz	A46473
230 V, 50 Hz, with FX241.5P rotor, CCC Plug	A58837

Specifications	
Maximum Speed	14,800 rpm
Maximum g-force	16,163 x g
Maximum capacity	24 x 2.2 mL
Drive Type	Brushless
Time Setting	0–99 minutes, 59 seconds, continuous, pulse (short run)
Accel/Decel Rates*	15 sec accel/13 sec decel to/from max speed
Power Consumption	95 W
Ambient Temperature Range	4°C to 40°C
Dimensions	17.6 cm (6.9 in) H x 26.6 cm (10.5 in) D x 22.6 cm (8.9 in) W
Weight	6.4 kg (14 lb)

1. Benchtop
2. Microcentrifugation
3. Tubes & Bottles
4. Tools & Supplies
5. Reference
6. Support

Microfuge 20 Series Microcentrifuge



The Microfuge 20 Series Microcentrifuges offers high *g*-force (20 627 x *g*) for optimal pelleting. Its maintenance-free motor spins up to 15 000 rpm. The Microfuge 20R maintains 4°C at maximum speed to protect precious samples perfect for DNA, RNA, proteins and virus cell isolation. Available with 4 interchangeable rotors.



Microfuge 20R Microcentrifuge

Specifications	Microfuge 20R	Microfuge 20
Maximum Speed	15,000 rpm	
Maximum <i>g</i> -force	20,627 x <i>g</i>	
Drive Type	Brushless induction	
Time Setting	Timed up 99 min 59 s, continuous run	
User Programs	10	
Accel/Decel Rates	Fast, Soft	
Temperature Setting	N/A	-10°C to 40°C
Ambient Temp Range	5°C to 40°C	5°C to 35°C
Power Consumption	170W	420W
Dimensions	29.1 cm (11.5 in) H x 66 cm (26 in) D x 31 cm (12.2 in) W	27 cm (10.7 in) H x 42 cm (16.5 in) D x 31 cm (12.2 in) W
Weight	32 kg (70.5 lb)	13 kg (28.6 lb)

Microfuge 20R	Configuration	Part Number
IVD	220-240V, 50/60Hz	B31611
	220-240V, 50Hz China	B31614
	120V, 60Hz	B31612
	100V, 50/60Hz	B31613
Non-IVD	220-240V, 50/60Hz	B31607
	220-240V, 50Hz, China	B31610
	120V, 60Hz	B31608
	100V, 50/60Hz	B31609

Centrifuge and Rotor Sales Groups available on page 2-3.

Microfuge 20	Configuration	Part Number
IVD	220-240V, 50/60Hz	B31603
	220-240V, 50 Hz, China	B31606
	120V, 60Hz	B31604
	100V, 50/60Hz	B31605
Non-IVD	220-240V, 50/60Hz	B31599
	220-240V, 50Hz, China	B31602
	120V, 60Hz	B31600
	100V, 50/60Hz	B31601

Centrifuge and Rotor Sales Groups available on page 2-3.

Centrifuge and Rotor Sales Groups

Microfuge 20	Microfuge 20							
	IVD				non-IVD			
	100V 50/60Hz	120V	220-240V 50/60Hz	220-240V 50Hz China	100V 50/60Hz	120V	220-240V 50/60Hz	220-240V 50Hz China
Centrifuge ONLY PN	B31605	B31604	B31603	B31606	B31601	B31600	B31599	B31602
FA241.5 Rotor Package centrifuge + FA241.5 FA rotor	-	B30138	B30578	-	-	-	B30577	-
FA241.5P Rotor Package centrifuge + FA241.5P FA rotor	B30135	B30137	B30141	B30143	B30134	B30136	B30140	B30142
FA361.5 Rotor Package centrifuge + FA261.5 FA rotor	-	B30139	B30580	-	-	-	B30579	-

Microfuge 20R	Microfuge 20R							
	IVD				non-IVD			
	100V 50/60Hz	120V	208-230V 60Hz	200-230V 50Hz	100V 50/60Hz	120V	208-230V 60Hz	200-230V 50Hz
Centrifuge ONLY PN	B31613	B31612	B31611	B31614	B31609	B31608	B31607	B31610
FA241.5 Rotor Package centrifuge + FA241.5 FA rotor	-	B30148	B5082	-	-	-	B30581	-
FA241.5P Rotor Package centrifuge + FA241.5P FA rotor	B30145	B30147	B30152	B30154	B30144	B30146	B30150	B30153
FA361.5 Rotor Package centrifuge + FA261.5 FA rotor	-	B30149	B30584	-	-	-	B30583	-

Microfuge Centrifuges Rotor Summary

Rotor Type	Part Number	Maximum Speed (rpm)	Maximum Force (g) at r _{max}	Number Tubes/Bottles and Size (diameter x length) mm	Rotor Capacity (mL)	Rotor Angle	BioSafe	Microfuge 16	Microfuge 20 Series
Fixed-Angle Rotors									
FA241.5	B30155	15,000	20,627	24 x 2.0 11 x 39	48.0	44°	No		•
FA241.5P	B30156	15,000	20,627	24 x 2.0 11 x 39	48.0	43°	No		•
FA361.5	B30157	15,000	20,124	36 x 2.0 11 x 39	72.0	50°/30°	Yes BIOC		•
FA4x8.2P	B30159	15,000	16,602	32 x 0.2 4 x 8	6.4	44°	No		•
FX121.5P	A46476	14,800	15,183	12 x 1.5/2.2 11 x 40	26.4	45°	No	•	
FX241.5P	A46475	14,800	16,163	24 x 1.5/2.2 11 x 40	52.8	32°/37°	No	•	

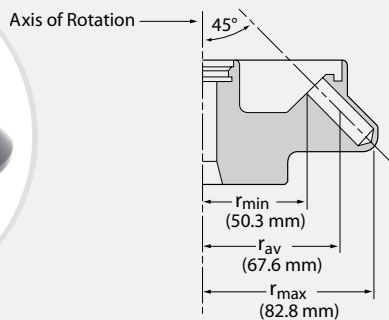

Fixed-Angle Rotor, Aluminum

Major applications: Pelleting subcellular organelles, DNA, viruses, bacteria or chloroplasts.

Max. rpm	Max. g	Number of Tubes Volume/Size	Approximate Accel/Decel Time (min:sec)
15,000	20,627	24 x 2.0 mL 10 x 31 mm	0:25/0:19

For use in Microfuge 20 Series Microcentrifuges

No. B30155. FA241.5 Rotor Assembly with snap-on plastic lid.

Tube Style/Material		Nominal Volume per Tube (mL)*	Part No.	Quantity	Size (mm)	Required Adapter	Tubes per Adapter	Maximum Speed
Polypropylene Natural, Attached cap		1.5	357448	500	11 x 40	364701	1	15,000
Polyethylene	Heparin-Lithium-Fluoride Coated	250 µL	652821	1000	5 x 45	361247	1	11,500
	Heparin-Lithium Coated	250 µL	652822	1000	5 x 45	361247	1	11,500
	Plain	250 µL	652823	1000	5 x 45	361247	1	11,500
	Heparin-Lithium-Fluoride Coated	400 µL	652824	1000	7 x 40	361247	1	11,500
	Heparin-Lithium Coated	400 µL	652825	1000	7 x 40	361247	1	11,500
	Plain	400 µL	314326	1000	7 x 40	361247	1	11,500
Attached cap		1.8	340196	500	11 x 45	364701	1	10,000
Polypropylene	Natural, Separate Cap	400.0 µL	342867	1000	7 x 40	361247	1	11,500
		1.5	343169	500	11 x 40	364701	1	15,000

* Unless otherwise noted.

Rotor Replacement Parts

B31096	Lid assembly (polycarbonate, snap-on)
B31097	Lid assembly (aluminum, screw-on)
368990	Rotor O-ring
368896	Screw-on lid O-ring
B31102	Tie-down screw
361371	T-handle wrench

Adapters

361247 | 364701



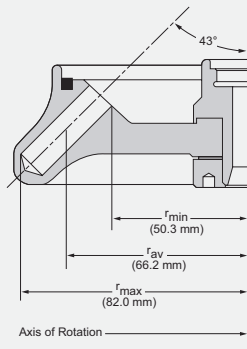

Fixed-Angle Rotor, Polypropylene

Major applications: Pelletting subcellular organelles, nucleic acids, viruses, bacteria or chloroplasts.

Max. rpm	Max. g	Number of Tubes Volume/Size	Approximate Accel/Decel Time (min:sec)
15,000	20,627	24 x 2.0 mL 10 x 31 mm	0:15/0:13

For use in Microfuge 20 Series Microcentrifuges

No. B30156. FA241.5P Rotor Assembly. Rotor is made of polypropylene and snap-on lid of high-impact thermoplastic.

		Tubes						
Tube Style/Material	Nominal Volume per Tube (mL)*	Part No.	Quantity	Size (mm)	Required Adapter	Tubes per Adapter	Maximum Speed	
Polypropylene	Natural, Attached cap	1.5	357448	500	11 x 40	364701	1	15,000
Polyethylene	Heparin-Lithium-Fluoride Coated	250 µL	652821	1000	5 x 45	361247	1	11,500
	Heparin-Lithium Coated	250 µL	652822	1000	5 x 45	361247	1	11,500
	Plain	250 µL	652823	1000	5 x 45	361247	1	11,500
	Heparin-Lithium-Fluoride Coated	400 µL	652824	1000	7 x 40	361247	1	11,500
	Heparin-Lithium Coated	400 µL	652825	1000	7 x 40	361247	1	11,500
	Plain	400 µL	314326	1000	7 x 40	361247	1	11,500
Polypropylene	Attached cap	1.8	340196	500	11 x 45	364701	1	10,000
	Natural, Separate Cap	400.0 µL	342867	1000	7 x 40	361247	1	11,500
		1.5	343169	500	11 x 40	364701	1	15,000

* Unless otherwise noted.

Rotor Replacement Parts

B31096	Lid assembly (polycarbonate, snap-on)
B31097	Lid assembly (aluminum, screw-on)
368990	Rotor O-ring
368896	Screw-on lid O-ring
B31102	Tie-down screw
361371	T-handle wrench

Adapters

361247 | 364701



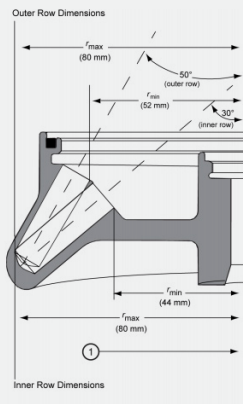

1. Axis of Rotation

Fixed-Angle Rotor, Aluminum

Major applications: Pelletting subcellular organelles, DNA, viruses, bacteria or chloroplasts.

Max. rpm	Max. g	Number of Tubes Volume/Size	Approximate Accel/Decel Time (min:sec)
15,000	20,124	36 x 2.0 11 x 39	0:36/0:20

For use in Microfuge 20 Series Microcentrifuges

No. B30157. FA361.5 BioSafe Rotor Assembly with aluminum screw-on lid.

Tube Style/Material		Nominal Volume per Tube (mL)*	Part No.	Quantity	Size (mm)	Required Adapter	Tubes per Adapter	Maximum Speed	
Polypropylene		Natural, Attached cap	1.5	357448	500	11 x 40	364701	1	15,000
Polyethylene	Heparin-Lithium-Fluoride Coated	250 µL	652821	1000	5 x 45	361247	1	11,300	
	Heparin-Lithium Coated	250 µL	652822	1000	5 x 45	361247	1	11,300	
	Plain	250 µL	652823	1000	5 x 45	361247	1	11,300	
	Heparin-Lithium-Fluoride Coated	400 µL	652824	1000	7 x 40	361247	1	11,300	
	Heparin-Lithium Coated	400 µL	652825	1000	7 x 40	361247	1	11,300	
	Plain	400 µL	314326	1000	7 x 40	361247	1	11,300	
Polypropylene	Attached cap	1.8	340196	500	11 x 45	364701	1	10,000	
	Natural, Separate Cap	400.0 µL	342867	1000	7 x 40	361247	1	11,500	
		1.5	343169	500	11 x 40	364701	1	15,000	

* Unless otherwise noted.

Rotor Replacement Parts

B31098	Lid assembly, BioSafe
368990	Rotor O-ring
368896	Lid O-ring
B31102	Tie-down screw
361371	T-handle wrench

Adapters

361247 | 364701



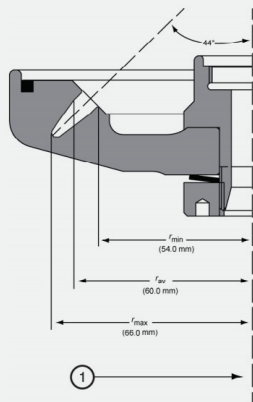

1. Axis of Rotation

Fixed-Angle Rotor, High-Impact Thermoplastic

Major applications: Pelleting subcellular organelles, DNA, viruses, bacteria or chloroplasts.

Max. rpm	Max. g	Number of Tubes Volume/Size	Approximate Accel/Decel Time (min:sec)
15,000	16,602	32 x 0.2 4 x 8	0:11/0:13

For use in Microfuge 20 Series Microcentrifuges

No. B30159. FA4x8.2P Rotor Assembly. Rotor is made of high-impact thermoplastic and snap-on lid is polycarbonate.

Tubes									
Tube Style/Material	Nominal Volume per Tube (mL)*	Part No.	Quantity	Size (mm)	Required Adapters	Tubes per Adapter	g-Force	k Factor	Maximum Speed
PCR* Tubes	200 μ L	-----	-----	-----	-----	-----	-----	-----	15,000

* Unless otherwise noted.

Rotor Replacement Parts	
B31096	Lid assembly (polycarbonate, snap-on)
B31097	Lid assembly (aluminum, screw-on)
368990	Rotor O-ring
369554	Tie-down screw
361371	T-handle wrench

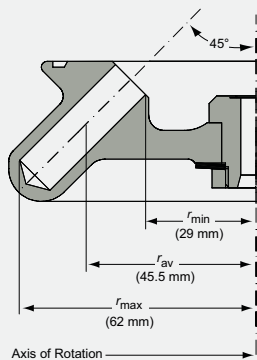

Fixed-Angle Rotor, High-Impact Thermoplastic

Major applications: Pelleting subcellular organelles, mitochondria, viruses, bacteria, chloroplasts or algae.

Max. rpm	Max. g	Number of Tubes Volume/Size	Approximate Accel/Decel Time (min:sec)
14,800	15,183	12 x 1.5/2.2 mL 11 x 40 mm 0.44 x 1.6 in	0:13/0:11

For use in Microfuge 16 Microcentrifuge.

No. A46476. FX121.5P Rotor Assembly. Rotor is made of high-impact thermoplastic and snap-on lid is polysulfone.

Tube Style/Material		Nominal Volume per Tube (mL)**	Part No.	Quantity	Size (mm)	Required Adapters	Tubes per Adapter	g-Force	k Factor	Maximum Speed
Polypropylene Natural		1.5	357448	500	11 x 40	-----	-----	15,183	-----	14,800
Polyethylene		250 µL	652821	1000	5 x 45	361247	1	-----	-----	11,500
		250 µL	652822	1000	5 x 45	361247	1	-----	-----	11,500
		250 µL	652823	1000	5 x 45	361247	1	-----	-----	11,500
		400 µL	652824	1000	7 x 40	361247	1	-----	-----	11,500
		400 µL	652825	1000	7 x 40	361247	1	-----	-----	11,500
		400 µL	314326	1000	7 x 40	361247	1	-----	-----	11,500
		1.9	340196	500	11 x 39	-----	-----	8,960	1,190	10,000
Polypropylene		1.5	343169	500	11 x 40	-----	-----	15,183	-----	14,800
PCR* Tubes		200 µL	†		-----	392294	-----	-----	-----	14,800
		500.0/600.0/750 µL	†		-----	364690	-----	-----	-----	14,800

* PCR is covered by patents owned by F. Hoffman-La Roche, Inc.

** Unless otherwise noted.

† Commercially available.

Rotor Replacement Parts

A46477	Convenient Polysulfone Snap-on Lid
--------	------------------------------------

Adapters		
361247	364690	392294

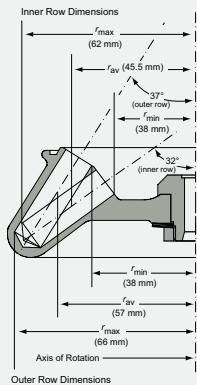

Fixed-Angle Rotor, High-Impact Thermoplastic

Major applications: Pelleting subcellular organelles, mitochondria, viruses, bacteria, chloroplasts or algae.

Max. rpm	Max. g	Number of Tubes Volume/Size	Approximate Accel/Decel Time (min:sec)
14,800	16,163	24 x 1.5/2.2 mL 11 x 40 mm 0.44 x 1.6 in	0:15/0:13

For use in Microfuge 16 Microcentrifuge.

No. A46475. FX241.5P Rotor Assembly. Rotor is made of high-impact thermoplastic and snap-on lid is polysulfone.

Tube Style/Material		Nominal Volume per Tube (mL)**	Part No.	Quantity	Size (mm)	Required Adapters	Tubes per Adapter	g-Force	k Factor	Maximum Speed
Polypropylene Natural		1.5	357448	500	11 x 40	-----	-----	15 183	-----	14,800
Polyethylene		250.0 µL	652821	1000	5 x 45	361247	1	-----	-----	11,500
		250.0 µL	652822	1000	5 x 45	361247	1	-----	-----	11,500
		250.0 µL	652823	1000	5 x 45	361247	1	-----	-----	11,500
		400.0 µL	652824	1000	7 x 40	361247	1	-----	-----	11,500
		400.0 µL	652825	1000	7 x 40	361247	1	-----	-----	11,500
		400.0 µL	314326	1000	7 x 40	361247	1	-----	-----	11,500
		1.9	340196	500	11 x 39	-----	-----	8 960	1,190	10,000
Polypropylene		1.5	343169	500	11 x 40	-----	-----	15 183	-----	14,800
PCR* Tubes		200.0 µL	†		-----	392294	-----	-----	-----	14,800
		500.0/600.0/750.0 µL	†		-----	364690	-----	-----	-----	14,800

* PCR is covered by patents owned by F. Hoffman-La Roche, Inc.

** Unless otherwise noted.

† Commercially available.

Rotor Replacement Parts

A46477	Convenient Polysulfone Snap-on Lid
--------	------------------------------------

Adapters

361247	364690	392294
--------	--------	--------



Tubes and Bottles for Every Application

No single tube design or material will meet all application requirements. A number of factors should be considered when a supply of tubes is ordered: the particular technique to be used, the nature of the sample and any solvent or gradient media, the desirability of reusing the tubes, and certain convenience factors. The properties listed below provide a guide for anyone involved in the tube selection process.

- **Strength and Flexibility**, to resist permanent deformation even when run in fixed angle rotors without tube caps
- **Chemical Resistance** to a wide range of bases, acids, and solvents
- **Transparency**, to permit a clear view of fractions and bands after centrifugation
- **Thin** enough to be sliced or punctured after centrifugation for fraction collection
- **Impermeable to Water**, to prevent aqueous solutions from permeating the tube wall and reaching the rotor cavity
- **Surface Properties** that prevent the adherence of nucleic acids and proteins
- **Temperature Tolerance** throughout a wide range of operating temperatures, without deforming at high temperatures or cracking when used close to 0°C
- **Autoclavable**, for convenient sterilization and reuse
- **Contaminant-free**, to avoid leaching extraneous materials into the sample, especially materials visible in the sensitive 240-280 nm range
- **Odor-free**, for pleasant handling

The full line of Beckman Coulter tubes includes a number of tube materials, each with its own distinct combination of properties to meet a variety of application requirements. Available are transparent, translucent, and opaque tubes; tubes that can be sliced or punctured; tubes that can be sterilized and reused; and tubes that are resistant to a variety of chemical compounds.

Tube Selection Considerations

Compatibility of Tube Material with Solvents and Sample

The chemical compatibility of the tube materials with the gradient-forming medium or other solvent is a prime consideration. Neutral sucrose and salt solutions cause no problem. But alkaline solutions, such as those frequently used for the separation of single-stranded forms of DNA, cannot be used in Ultra-Clear™ tubes or polycarbonate tubes and bottles. Sometimes DMSO is used in preparation of sucrose gradients for sedimentation of denatured RNA. Polycarbonate and Ultra-Clear tubes are incompatible with DMSO, so polypropylene tubes should be used.

The last column of the “Quick Reference Chart to Tube Materials and Their Properties” on page 3-4 gives some guidelines to the chemical resistances of the various tube materials. It must be emphasized, however, that other conditions of centrifugation (*g*-force, duration of run, etc.) have considerable effect on how well a tube material will withstand a particular solvent. Beckman Coulter publication IN-175, “Chemical Resistances for Beckman Coulter Centrifugation Products” (found on the Beckman Coulter web site at beckman.com/techdocs) provides more detailed information about the chemical resistances of the various tube materials. The wisest course is to test any questionable combination under operating conditions before making the actual run.

The type of sample, in some cases, will affect selection of a specific tube material. DNA, in its denatured or single-stranded form, will adhere to the surface of some tube materials. Polypropylene would be the best choice. (Most of this work is done in highly alkaline media which are incompatible with polycarbonate.)

Lipoprotein separations are most often done in Ultra-Clear tubes because they are clear and sliceable; these properties simplify fraction location and recovery by tube slicing. When small lipoprotein samples are to be recovered by a fractionating device and clear tubes are desirable, there are alternatives: cellulose propionate, polycarbonate, and Ultra-Clear tubes.

Hazardous materials, either pathogenic or radioactive, should be centrifuged with extreme care. All possible precautions must be taken to avoid leakage of the sample into the rotor cavity during centrifugation.

To determine the optimum tube material for your specific sample and gradient medium, refer to the quick reference chart on page 3-4.

Gradient Formation and Fractionation

When choosing a tube for a density gradient run, some thought should be given to gradient formation and fractionation. If the bands or zones formed during centrifugation are indistinct, they may not be visible through a translucent material such as polypropylene. If optimum band visualization is important, Ultra-Clear tubes or tubes of polycarbonate or cellulose propionate should be used. Whenever collection of bands or zones must be done by puncturing the tube or slicing, a thin, flexible tube wall is required. Ultra-Clear or polypropylene tubes should be used, depending on the need for transparency.

As there are currently no wettable plastic centrifuge tubes available, gradients should be loaded into plastic tubes from the bottom up to avoid mixing.

High Temperature Centrifugation

Although modern centrifuges and rotors can operate at temperatures as high as 45°C, one cannot assume that every tube can be safely run over 25°C. Stainless steel and glass are the only materials which will not experience some deformation when subjected to high temperatures and long centrifugation times. Plastic tubes undergo some degree of softening at temperatures higher than 25°C. Whether or not this will cause permanent deformation is not a question of temperature alone. The centrifugal force field used, the duration of the centrifugation, the type of rotor, and even the tube angle all have an effect.

It's obviously impossible to give exact temperature limits for plastic tubes when so many other variables are involved. The safest policy is to pretest the tubes under the actual experimental conditions, but with water, rather than a valuable sample.

Tube Sizes

Tube sizes as indicated in the following charts are nominal sizes, and may vary somewhat from actual filling capacities. If a thickwall tube is run uncapped, the maximum filling volume will depend on the tube angle of the rotor to be used. See appropriate rotor instruction manuals for maximum filling levels of tubes.

Tube Cleaning, Sterilization, and Reuse

If tubes are to be reused, special care must be taken during cleaning and sterilization. All tubes can be washed by hand with a mild detergent such as Solution 555™ diluted 5-to-1 or 10-to-1 with water. This is particularly important for polycarbonate tubes and bottles which should not be exposed to a detergent with a pH higher than 8. Tubes and bottles should not be washed in commercial dishwashers as the detergents and high temperatures are too harsh. Solvents such as alcohol or acetone react unfavorably with many tube materials. If an organic solvent must be used in the cleaning procedure, consult bulletin IN-175 for a table of tube material/solvent compatibilities (or review the same document on the Beckman Coulter web site at beckman.com/techdocs).

The method chosen for sterilization has direct bearing on the number of reuses one can expect from a tube. Tubes and bottles of polypropylene, polyethylene, and glass can all be autoclaved, although in general, cold sterilization methods are not as harsh as autoclaving. Cold sterilization is recommended for both polycarbonate and Ultra-Clear.

If maximum reuse is a major consideration, either polypropylene (preferably thickwall) or polycarbonate tubes and bottles should be selected, and cold sterilization methods used. If these tubes are run completely filled in swinging bucket rotors, most of them can be reused a number of times. Chances of permanent deformation will be greater whenever the tubes are run in fixed angle rotors, without caps, and/or partially filled. All of these conditions tend to stress the centripetal edge of the tube unduly. All tubes that have been used or autoclaved previously must be individually examined for signs of deformation or cracking before using them again.

Tube Closures

When other considerations have been resolved, convenience may be a deciding factor. Without a doubt, the most convenient tube closure is none at all; none are required for tubes run in swinging bucket rotors.

For tubes run in fixed angle rotors, alternatives to the standard tube cap assemblies are available. Bottles have three-piece cap assemblies which are easier to use than the more complex tube cap assemblies. Polycarbonate bottles are available for general-purpose fixed angle rotors, and are used frequently for differential centrifugation where band recovery is not a problem. Thickwall tubes can be run in all fixed angle rotors without caps, provided they are partially filled. (Refer to rotor manuals for more information on fill volumes.)

When closed tubes are required, Beckman Coulter offers some innovative and convenient options.

A Quick-Reference Chart to Tube Materials and Their Properties

Property	Thinwall Polypropylene	Thickwall Polypropylene	Ultra-Clear™	Polycarbonate	Polypropylene	Polyethylene	Cellulose Propionate
Optical	transparent	translucent	transparent	transparent	translucent	transparent/translucent	transparent
Autoclaveable	yes	yes	no	no	yes	no	no
Puncturable	yes	no	yes	no	no	yes	no
Sliceable	yes	no*	yes	no*	no	no	no*
Reusable	no	yes	no	yes	yes	yes	no
Acids (dilute or weak)	S	S	S	S	S	S	S
Acids (strong)	U	S	U	U	S	S	U
Alcohols (aliphatic)	U	S	U	U	S	S	U
Aldehydes	M	M	S	M	M	S	U
Bases	S	S	U	U	S	S	U
Esters	U	M	U	U	M	S	M
Hydrocarbons (aliphatic)	U	M	U	U	S	U	S
Hydrocarbons (aromatic and halogenated)	U	U	U	U	M	M	S
Ketones	U	M	U	U	M	M	U
Oxidizing Agents (strong)	U	U	U	M	M	M	M
Salts	S	S	M	M	S	S	S

S = satisfactory resistance M = marginal resistance U = unsatisfactory resistance

* Polypropylene, polycarbonate, and cellulose propionate tubes with diameters of 5 to 13 mm may be sliced using the CentriTube Slicer (part number 347960) and appropriate adapter plate.

Note: This information has been consolidated from a number of sources and is provided only as a guide to the selection of tube materials. Soak tests at 1 g (at 20°C) established the data for most of the materials; reactions may vary under the stress of centrifugation, or with extended contact or temperature variations. To prevent failure and loss of valuable sample, ALWAYS TEST SOLUTIONS UNDER OPERATING CONDITIONS BEFORE USE.

Warning: Do not use flammable substances in or near an operating centrifuge.

General Filling and Sealing Requirements for Tubes and Bottles

	Tube or Bottle	Swinging-Bucket Rotors	Fixed-Angle Rotors
Polypropylene	Thinwall tubes	Within 2 to 3 mm of top	Full with cap
	Thickwall tubes	At least 1/2 full	1/2 full to max. capless level or full with cap
	Quick-Seal® tubes	Full and heat-sealed	Full and heat-sealed
	Bottles	Min. to max. (see rotor manual) with screw-on cap or cap assembly	1/2 full to max. (see rotor manual) with screw-on cap or cap assembly
Ultra-Clear™	Open-top tubes	Within 2 to 3 mm of top	Full with cap
	Quick-Seal tubes	Not used	Full and heat-sealed
Polycarbonate	Thickwall tubes	At least 1/2 full	1/2 full capless level or full with cap or cap assembly
	Bottles	At least 1/2 full	Min. to max. (see rotor manual) with screw-on cap or cap assembly
Stainless Steel	Tubes	Any level	Any level with cap or cap assembly
Polypropylene	Tubes and bottles	At least 1/2 full	1/2 to max. capless level or full with cap or cap assembly
Polyethylene	Tubes	At least 1/2 full	1/2 to max. capless level or full with cap or cap assembly
Teflon	Tubes and bottles	At least 1/2 full	1/2 full to max. capless level or full with cap

TUBES AND BOTTLES

Bottles Used in Benchtop Centrifuges

Nominal Capacity	Size mm	Material	Bottle & Cap Assy	Bottle with Screw Cap	Bottle Only	Insert Only	O-ring	Screw Cap Only
10 mL	16 x 80	PC	N.A.	355672	N.A.	N.A.	N.A.	N.A.
10 mL	16.1 x 81.1	PP	N.A.	364695	N.A.	N.A.	N.A.	N.A.
10 mL	16.1 x 81.1	T	N.A.	364693	N.A.	N.A.	N.A.	N.A.
26.3 mL	25 x 89	PC	355616	N.A.	340382	335258	870385	335259
30 mL	25.3 x 92	PP	363073	N.A.	N.A.	N.A.	N.A.	N.A.
30 mL	25.3 x 92	PC	N.A.	363070	N.A.	N.A.	N.A.	N.A.
40 mL	29 x 104	PC	N.A.	355628	N.A.	N.A.	N.A.	N.A.
50 mL	28.5 x 107	T*	N.A.	363076	N.A.	N.A.	N.A.	N.A.
50 mL	29 x 104	PP	357001 361694	357003	N.A.	358627	870655	356284
50 mL	29 x 104	PC	357000 361693	357002	N.A.	358627	961582	N.A.
70 mL	38 x 102	PC	355620	N.A.	355655	334545	870384	334547
85 mL	38 x 104	PC	363081	364718	N.A.	N.A.	N.A.	N.A.
85 mL	38 x 104	PP	N.A.	364719 363082	N.A. N.A.	N.A. N.A.	N.A. N.A.	N.A. N.A.
100 mL	38 x 102	PP	355624	N.A.	355626	N.A.	889633	355615
250 mL	62 x 120	W PC	356013	N.A.	358275	N.A.	927860	358977
250 mL	62 x 122	W PP	356011 358275 358326	N.A.	358326	N.A.	927860	358977
250 mL round-bottom	62 x 136	PC	N.A.	355673	N.A.	N.A.	N.A.	356261
500 mL	69 x 160	PC	355649	N.A.	339245	N.A.	N.A.	N.A.
500 mL	69 x 160	PP	355607	N.A.	355650	334419	870411	356260
500 mL	69 x 160	W PP	N.A.	355665	N.A.	N.A.	N.A.	N.A.
500 mL	85 x 135	PC	N.A.	368454	N.A.	N.A.	N.A.	N.A.
500 mL	85 x 135	PP	N.A.	368453	N.A.	N.A.	N.A.	N.A.
750 mL	96 x 130	PC	N.A.	358299	358297	N.A.	N.A.	344693
750 mL	96 x 130	PP	N.A.	356855	349815	N.A.	N.A.	344693

PC = Polycarbonate PE = Polyethylene PP = Polypropylene T = Teflon W = Wide-Mouth N.A. = Not Available

* With high-speed screw cap.

TUBES AND BOTTLES

Adapters for Non-Beckman Coulter Tubes/Bottles*

Rotor	Tube Vol.	Size (mm)	# of Places	Part Number
SX4250/SX4400	0.5 mL	7 x 19 mm	24	368471
	5 mL	12 x 75 mm	25	392263
	5 mL	Hemolyse/RIA	16	368467
	5 mL	13 x 75 mm	16	368467
	7 mL	12 x 100 mm	16	368469
	10 mL	16 x 100 mm	12	368465
	10 mL	17 mm	12	368465
	10 mL	16.1 x 81.1 mm	12	368468
	10/15 mL	17 x 110 mm	12	368465
	15 mL	16 x 125 mm	12	368467
	15 mL	17 x 120 mm	5	392257
	25 mL	24 x 100 mm	5	368463
	50 mL	28.5 x 100 mm	5	368463
	50 mL	28.5 x 107 mm	4	368477
	50 mL	28.5 x 100 mm	3	392258
	50 mL	34 x 100 mm	3	392265
	85/94 mL	38 x 112 mm	1	392261
	80/100 mL	44 x 100 mm	1	368459
	125 mL	50.5 x 99 mm	1	368458
	180 mL	56.5 x 99 mm	1	368457
250 mL	61.8 x 125 mm	1	392256	
JA-10.100	Conical 15 mL	17 x 100 mm	1	392270
	30 mL		1	392822
	35 mL		1	392821
	Conical 50 mL	28.5 x 120 mm	1	392268
FX301.5	500-700 µL		1	364690
H6002	600 µL		12	345526
				345522
SX241.5	500-700 µL		1	364690

Adapters for Glass Tubes in Beckman Coulter Rotors*

Rotor	Tube Volume	Tube Material	Adapter Part Number
SX4250	80/100 mL	Glass	368459
	50 mL	Glass	392258
	25 mL	Glass with Open-top or Screw-on Cap	398463
	7 mL	Glass	368469

* Check with tube manufacturer for maximum allowable g-force.

TUBES AND BOTTLES

Tubes and Bottles Used in Benchtop Centrifuges and Microcentrifuges

Nominal Filling Capacity (mL)	Nominal Size (mm)	Inches	Part No.	Rotors
Open-Top Tubes, Polypropylene, Thickwall*				
6.5	16 x 64	0.65 x 2.5	355646	F1010, S0410
10.0	16 x 76	0.65 x 3.0	355640	F1010, JS-4.750, S0410, JA-10.100
32.0	25 x 89	1.0 x 3.5	355642	F0630
81.0	38 x 102	1.5 x 4.0	355643	F0485, F0685, JA-10.100
Open-Top Tubes, Polycarbonate, Thickwall*				
6.5	16 x 64	0.65 x 2.5	355647	F1010, S0410
10.0	16 x 76	0.65 x 3.0	355630	F1010, JS-4.750, S0410, JA-10.100
15.0	18 x 100	0.725 x 4.0	342080	JS-4.750, JA-10.100
50.0	18 x 98	1.125 x 4	363647	F0485, F0650, F0850, F0685, JS-4.750, JA-10.100
50.0	29 x 104	1.25 x 4	363075 (conical, grad.)	F0650, F0850, JS-4.750, JA-10.100
81.0	38 x 102	1.5 x 4.0	355628	F0485, F0685, JA-10.100
Open-Top Tubes, Polypropylene				
34.0	25 x 76	1.0 x 3.0	326825	F0630
94.0	38 x 102	1.5 x 4.0	345775	F0485, F0685
Open-Top Tubes, Polyethylene, Plain				
0.25	5 x 45	0.2 x 1.8	652823	F1202, F2402H, FA241.5, FA241.5P, F3602, FX301.5, H6002, SX241.5, FA361.5, FX241.5P, FX121.5P
0.40	7 x 40	0.25 x 1.5	314326	F1202, F2402H, FA241.5, FA241.5P, F3602, FX301.5, H6002, SX241.5, FA361.5, FX241.5P, FX121.5P
15.0	18 x 98	0.725 x 4.0	342081	JS-4.750, JA-10.100
Open-Top Tubes, Polyethylene, Heparin/Lithium Coated				
0.25	5 x 45	0.2 x 1.8	652822	F1202, F2402H, FA241.5, FA241.5P, F3602, FX301.5, H6002, SX241.5, FA361.5, FX241.5P, FX121.5P
0.40	7 x 40	0.25 x 1.5	652825	F1202, F2402H, FA241.5, FA241.5P, F3602, FX301.5, H6002, SX241.5, FA361.5, FX241.5P, FX121.5P
Open-Top Tubes, Polyethylene, Heparin/Lithium/Fluoride Coated				
0.25	5 x 45	0.2 x 1.8	652821	F1202, F2402H, FA241.5, FA241.5P, F3602, FX301.5, H6002, SX241.5, FA361.5, FX241.5P, FX121.5P
0.40	7 x 40	0.25 x 1.5	652824	F1202, F2402H, FA241.5, FA241.5P, F3602, FX301.5, H6002, SX241.5, FA361.5, FX241.5P, FX121.5P
Open-Top Tubes, Polypropylene				
15.0	18 x 98	0.725 x 4	342082	JS-4.750, JA-10.100
50.0	29 x 104	1.125 x 4	357007	F0485, F0650, F0850, F0685, JS-4.750, JA-10.100
Open Top Tubes, UltraClear™				
13.5	16 x 76	0.65 x 3.0	344085	F1010, S0410
38.5	25 x 89	1.0 x 3.5	344058	F0630
Tubes with Snap-On Attached Caps, Polypropylene				
1.5	11 x 38	0.4 x 1.5	357448 - Natural	F1202, F2402H, FA241.5, FA241.5P, F3602, FX301.5, JS-4.750, H6002, SX241.5, FA361.5, JA-10.100, FX241.5P, FX121.5P

* Nominal fill volume for these tubes can vary from 6.0 to 10.0 mL, depending on the rotor in which it is used due to different tube angles.

TUBES AND BOTTLES

Nominal Filling Capacity (mL)	Nominal Size (mm)	Inches	Part No.	Rotors
Tubes with Snap-On Caps, Polycarbonate*				
50	29 x 104	1.125 x 4	363664	F0850, JS-4.750
Tubes with Snap-On Caps, Polyethylene				
1.9	11 x 39	0.4 x 1.5	340196 - Natural	F1202, F2402H, FA241.5, FA241.5P, F3602, JS-4.750, H6002, SX241.5, JA-10.100, FX241.5P, FX121.5P, FA361.5
Tubes with Snap-On Caps, Polypropylene				
1.5	11 x 38	0.4 x 1.5	356090 - Natural	JS-4.750
1.5	11 x 38	0.4 x 1.5	356091 - Blue	JS-4.750
1.5	11 x 38	0.4 x 1.5	356092 - Green	JS-4.750
1.5	11 x 38	0.4 x 1.5	356093 - Yellow	JS-4.750
1.5	11 x 38	0.4 x 1.5	356094 - Orange	JS-4.750
Tubes with Snap-On Caps, Polypropylene				
0.4	7 x 40	0.25 x 1.5	342867	F1202, F2402H, FA241.5, FA241.5P, F3602, H6002
0.5	8 x 28	0.25 x 1.25	344319	F1202, F2402H, H6002
1.5	11 x 38	0.4 x 1.5	343169- Natural	F1202, F2402H, FA241.5, FA241.5P, F3602, FX301.5, JS-4.750, H6002, SX241.5, FA361.5, JA-10.100, FX241.5P, FX121.5P
50	29 x 103	1.125 x 4	357005	F0850, JS-4.750
Bottles with Cap Assemblies, Polycarbonate				
50	29 x 104	1.25 x 4	363075 (polycarbonate, graduated)	F0650, F0850, JS-4.750, JA-10.100
Bottles with Screw-on Caps, Polycarbonate				
230	62 x 141	2.5 x 5.55	356987 (polycarbonate bottle with screw cap)	JS-4.750
Bottles with Screw-on Caps, Polypropylene				
230	62 x 141	2.5 x 5.5	356989 (polypropylene bottle with screw cap)	JS-4.750
Bio-Vial Tubes				
4	14 x 55	0.5625 x 2.25	566353 - Polypropylene	JS-4.750
Bottles with Cap Assemblies, Polypropylene				
50	29 x 104	1.25 x 4	357001	F0650, F0850, JS-4.750
50	29 x 104	1.25 x 4	361694	F0650, F0850, JS-4.750
Bottles with Cap Assemblies, Polycarbonate				
26.3	25 x 89	1.0 x 3.5	355616	F0630
50	29 x 104	1.25 x 4.25	361693	JS-4.750
50	29 x 104	1.25 x 4.25	357000	F0650, F0850, JS-4.750, TA-10-250
70	38 x 102	1.5 x 4.0	355620	F0485, F0685, JA-10.100
85	38 x 104	1.5 x 4.2	363081 (high-speed cap)	F0485, F0685, JA-10.100
250	62 x 122	2.5 x 4.75	358275 (wide mouth)	JS-4.750

* Nominal fill volume for these tubes can vary from 6.0 to 10.0 mL, depending on the rotor in which it is used due to different tube angles.

1. Benchtop

2. Microcentrifugation

3. Tubes & Bottles

4. Tools & Supplies

5. Reference

6. Support

TUBES AND BOTTLES

Nominal Filling Capacity (mL)	Nominal Size (mm)	Inches	Part No.	Rotors
Bottles with Cap Assemblies, Polypropylene				
250	62 x 120	2.5 x 4.75	358326 (wide mouth)	JS-4.750
250	62 x 122	2.5 x 4.75	356011 (wide mouth)	JS-4.750
500	69 x 160	2.75 x 6.5	355607	JS-4.750
Bottles with Screw-on Caps, Polypropylene				
10	16 x 81	0.75 x 3.25	364695	F1010, S0410
30	25.3 x 92	1.0 x 3.75	363073	F0630
50	29 x 104	1.25 x 4.0	357003	F0485, F0650, F0685, F0850, JS-4.750, JA-10.100
Bottles with Screw-on Caps, Polycarbonate				
10	16 x 80	0.6 x 3.2	355672	F1010, S0410
30	25.3 x 92	1.0 x 3.75	363070	F0630
50	29 x 104	1.125 x 4.0	357002	F0485, F0650, F0685, F0850, JS-4.750, JA-10.100
85	38 x 104	1.5 x 4.0	363081	F0485
230	62 x 141	2.5 x 5.25	356987 (conical)	JS-4.750
250	62 x 120	2.5 x 4.75	356013 (wide mouth)	JS-4.750
250	62 x 136	2.5 x 5.5	355673	JS-4.750
750	96 x 130	3.75 x 5.25	358299	JS-4.750
Bottles with Screw-on Caps, Polypropylene				
85	38 x 104	1.5 x 4.0	363082	F0685, JA-10.100
85	38 x 104	1.5 x 4.0	364719	F0485
100	38 x 102	1.5 x 4.0	355624	F0485, F0685, JA-10.100
230	62 x 141	2.5 x 5.5	356989 (conical)	JS-4.750
500	69 x 159	2.75 x 6.5	355665	JS-4.750
750	96 x 130	3.75 x 5.25	356855	JS-4.750
Bottles with Screw-on Caps, Teflon				
10	16 x 81	1.25 x 3.25	364693	F1010, S0410
50	28.5 x 107	1.25 x 4.25	363076	F0650, F0850, JS-4.750

1. Benchtop

2. Microcentrifugation

3. Tubes & Bottles

4. Tools & Supplies

5. Reference

6. Support

Rotor Cleaning Kit



339558	Rotor Cleaning Kit. Contains two 946-mL bottles of Solution 555™ Rotor Cleaning Concentrate, 339379 Rotor Cleaning Brush, and 339380 Rotor Cleaning Brush
--------	---

Replacement Parts/Supplies

339555	Solution 555 Rotor Cleaning Concentrate (min. order two Bottles)
339379	Rotor Cleaning Brush, 5/8-in. (16 mm) and 1-in. (25.4 mm), for Rotor Cavity diameters from 7/16-in. (11 mm) to 1-in. (25.4 mm) (min. order three Brushes)
339380	Rotor Cleaning Brush, 1 1/4-in. (32 mm) and 1 1/2-in. (38 mm), for Rotor Cavity diameters from 1-in. (25.4 mm) to 1 1/2-in. (38 mm) (min. order three Brushes)

Useful Formulas

k Factor

To determine *k* factor

$$k = \frac{\ln (r_{\max} / r_{\min})}{\omega^2} \times \frac{10^{-13}}{3600} \quad \text{OR} \quad k = \frac{2.53 \times 10^5 \ln (r_{\max} / r_{\min})}{(\text{RPM}/1000)^2}$$

To determine pelleting time in hours (*t*)

$$t = \frac{k}{s} \quad \text{where } s = \text{sedimentation coefficient in Svedbergs}$$

To relate pelleting time between rotors

$$\frac{k_1}{t_1} = \frac{k_2}{t_2}$$

To adjust *k* factor for runs less than maximum rotor speed

$$k_{\text{adj}} = k \left(\frac{\text{maximum rated speed of rotor}}{\text{actual run speed}} \right)^2$$

To relate relative centrifugal force (RCF) to speed (RPM):

$$\text{RCF}_{\max} = 1.12 r_{\max} \left(\frac{\text{RPM}}{1000} \right)^2 \quad \text{OR} \quad \text{RPM} = 10^3 \sqrt{\frac{\text{RCF}}{1.12 r_{\max}}}$$

*r*_{max} in mm

To relate the sedimentation coefficient (s) to rotational speed:

$$s = \frac{dr}{dt} \times \frac{1}{\omega^2 r}$$

Svedberg unit (S) equivalent:

$$S = 10^{-13} \text{ seconds}$$

Reduced run speed for dense solutions:

$$\text{reduced run speed} = \text{max rated speed of rotor} \times \sqrt{A/B}$$

where A = max. permissible density of rotor tube contents, and
B = actual density of the tubes to be centrifuged

Field Service Support

Most of us appreciate the need for careful design, handling, and maintenance of certain kinds of laboratory equipment—the optics of a spectrophotometer, for example. It may not be obvious, however, that anything as substantial looking as a centrifuge rotor must be properly maintained during use in order for it to fulfill its life expectancy.

If you consider that, during rotation, an Ultracentrifuge Rotor may experience more than 1,000,000 times the force of gravity, it becomes apparent that seemingly minor flaws will assume much greater significance at these *g*-forces. In effect, one gram will “weigh” 1,000 kilograms, and a tiny flaw in a critical part may generate stresses greater than the rotor was designed to withstand.

We at Beckman Coulter maintain stringent quality standards and rigorously test every rotor design. Specific instructions for care and maintenance are included in the rotor manual that accompanies each rotor. And our Field Rotor Inspection Program is available at no charge to all users of Beckman Coulter Ultracentrifuges and High-Speed Centrifuges.

Field Rotor Inspection Program. What Is It?

Our Field Rotor Inspection Program (FRIP) has two purposes: to prevent premature rotor failures by detection of stress corrosion, metal fatigue, wear or damage to anodized coatings; and to instruct laboratory personnel in the proper care of rotors.

Contact your local Beckman Coulter Service Office for details on the Field Rotor Inspection Program. Using nondestructive methods (fiber optics borescopy and dyepenetrant analysis), they may find signs of corrosion or other damage. If so, they will recommend repair or replacement, and a potentially costly failure may be prevented.

To give a fuller understanding of rotors, a comprehensive slide presentation is also offered. Centrifuge users are informed about maintenance procedures, rotor damage, and its significance. The stress corrosion of aluminum rotors, in particular, can be greatly reduced by good laboratory practice.

Sometimes rotor corrosion is so bad it can be seen by the naked eye, while at other times it is not so apparent. If you have doubt about the condition of a single Beckman Coulter rotor, you may return it to the factory where it will be inspected free of charge by our metallurgists. The rotor will be examined by a variety of nondestructive methods, including ultrasound which is capable of detecting internal flaws. Before shipping the rotor, you must contact the nearest Beckman Coulter Sales and Service office for specific instructions. A written statement must accompany each rotor, indicating that it is safe to handle, (i.e. free of any pathogenic or radioactive contamination).

Rotor Safety Seminars

To help you get the most from your Beckman Coulter rotors, Rotor Safety Seminars are frequently presented by our Field Service engineers. Seminars are designed to remind centrifuge users about the importance of proper rotor care and maintenance.

When you attend a Beckman Coulter Rotor Safety Seminar, you will have an opportunity to ask questions that are specific to your particular situation, and you will learn:

- What causes corrosion in a rotor, where it starts, what it does to the rotor, and how to avoid it.
- The proper way to clean and store rotors.
- How to get longer life from your rotor.

On-Site Rotor Inspection and Maintenance

Specially trained Beckman Coulter Field Service engineers are available at your request for on-site inspection and minor rotor maintenance. Rotors that are free of biological and radiological contamination can be brought to these sessions for immediate inspection so you can continue operating your centrifuge with confidence in the condition of your rotors.

A Comprehensive Approach to Centrifuge System Care

Throughout the world, Beckman Coulter Field Service engineers are on hand to provide the support you need. So you can operate your centrifuges worry-free, a number of programs are in place that cover preventive maintenance of your system, including parts, labor, drive systems, and rotors. It all adds up to a comprehensive approach to maximizing your system investment.

Contact your local Beckman Coulter Sales and Service office to find out the specifics about the program available in your area.

A global presence. Focused on individuals.

We may not be a household name. Yet we touch people the world over by developing, manufacturing and marketing discovery systems and products that improve human health.

For over 75 years, we've been building a global reputation in hospitals, labs, and universities, where our life science research instruments are relied upon to perform vital roles day in and day out. Whether helping to solve complex biological problems, investigate the causes of disease, or find potential new cures, Beckman Coulter is focused on innovations that ultimately lead to healthier lives.

beckman.com/centrifuges



BioSafe and BioSafety are terms intended to describe the enhanced biocontainment features of our products.



BioCertified is a term used to describe our products which have been tested and validated to demonstrate containment of microbiological aerosols by an independent, third-party facility (Health Protection Agency, Porton Down, UK). Improper use or maintenance may affect seal integrity and, thus, containment.



BioEnhanced is a term intended to describe our products' enhanced level of biocontainment by design.